



# MAX9851 Evaluation Kit/Evaluation System

## General Description

The MAX9851 evaluation system (MAX9851EVCMODU) consists of a MAX9851 evaluation kit (EV kit), a companion Maxim command module (CMODUSB) interface board, and software. The MAX9851 EV kit is a fully assembled and tested surface-mount printed-circuit board (PCB) that evaluates the MAX9851 stereo audio GSM/GPRS/EDGE CODEC with microphone inputs, DirectDrive™ headphone amplifiers, receiver amplifier, and stereo speaker amplifiers. The EV kit is designed to send and receive digital audio data in the Sony/Philips digital interface (S/PDIF) format and can be optionally configured to communicate using generic digital audio or I<sup>2</sup>S-compatible signals. The EV kit provides RCA jacks for connecting analog input signals and digital S/PDIF signals. A 3.5mm headphone jack provides easy connection of headphones to the PCB. The Maxim command module interface board (CMODUSB) provides an I<sup>2</sup>C interface through a PC serial or USB port. Windows® 98/2000/XP-compatible software, which can be downloaded from the Maxim website, provides a user-friendly interface to exercise the features of the MAX9851. The program is menu driven and offers a graphical user interface (GUI) with control buttons and a status display. The MAX9851EVCMODU includes the EV kit and the CMODUSB interface board. Order the MAX9851EVKIT if no Maxim command module interface is needed.

**Note:** The MAX9851 EV kit software is provided with the MAX9851EVKIT; however, the CMODUSB board is required to interface the EV kit to the computer when using the included software.

Windows is a registered trademark of Microsoft Corp.

## Features

- ◆ 3.5V to 5.5V Single-Supply Operation
- ◆ I<sup>2</sup>C 2-Wire Serial Interface
- ◆ Electrical S/PDIF Input/Output
- ◆ On-Board 26MHz Crystal Oscillator
- ◆ Two On-Board S/PDIF Digital Audio Receivers
- ◆ One On-Board S/PDIF Digital Audio Transmitter
- ◆ On-Board Power-Management IC
- ◆ Isolation Header for Direct Communication with the MAX9851 I<sup>2</sup>C and Digital Audio Interfaces
- ◆ Easy-to-Use Menu-Driven Software
- ◆ Assembled and Tested
- ◆ Includes Windows 98/2000/XP-Compatible Software and Demo PCB to Evaluate the MAX9851

## Ordering Information

PART	TYPE
MAX9851EVKIT	EV Kit
MAX9851EVCMODU	EV System

## System Diagram

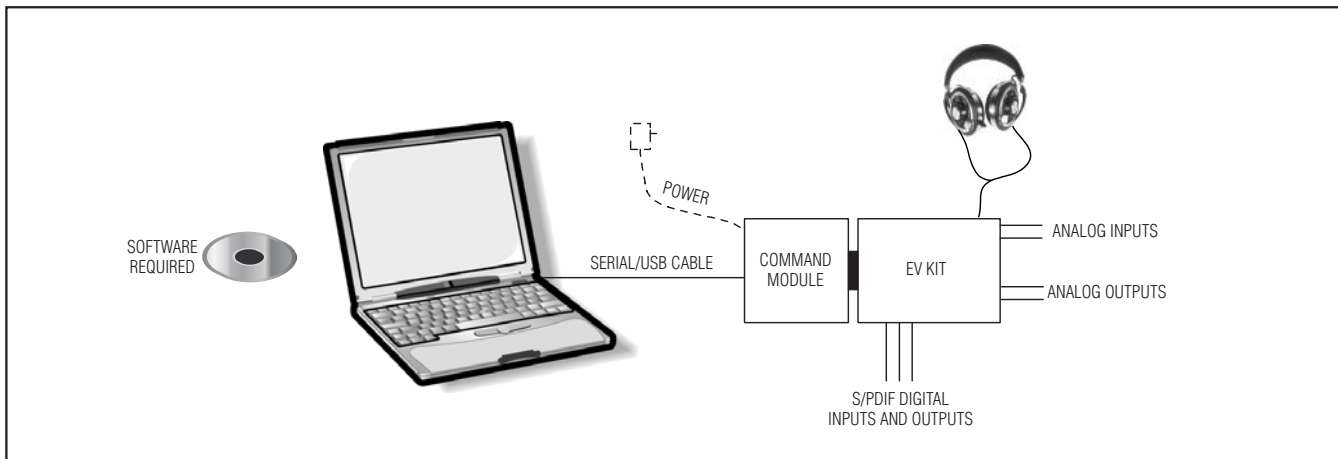

# MAX9851 Evaluation Kit/Evaluation System

Evaluate: MAX9851

## Component List

DESIGNATION	QTY	DESCRIPTION
<b>REQUIRED COMPONENTS</b>		
C1, C5, C6	3	0.1 $\mu$ F $\pm$ 10%, 10V X5R ceramic capacitors (0402) TDK C1005X5R1A104K
C2, C3, C4, C7, C9–C19, C94	16	1.0 $\mu$ F $\pm$ 10%, 6.3V X5R ceramic capacitors (0402) TDK C1005X5R0J105M
C8	1	1.0 $\mu$ F $\pm$ 10%, 6.3V X5R ceramic capacitor (0603) TDK C1608X5R0J105K
C20	1	0.22 $\mu$ F $\pm$ 20%, 16V X7R ceramic capacitor (0603) TDK C1608X7R1C224M
C54	1	10 $\mu$ F $\pm$ 20%, 6.3V X5R ceramic capacitor (0805) TDK C2012X5R0J106M
R3	1	1.0k $\Omega$ $\pm$ 5% resistor (0603)
R20	1	10k $\Omega$ $\pm$ 5% resistor (0603)
<b>SUPPORT COMPONENTS</b>		
C21, C22, C23, C28, C29, C30, C38, C39, C55, C59, C63, C68, C71, C76, C77, C78	16	1.0 $\mu$ F $\pm$ 10%, 6.3V X5R ceramic capacitors (0402) TDK C1005X5R0J105M
C24, C25, C31, C32, C37, C66, C69, C72, C74, C80, C86, C88, C90	13	0.01 $\mu$ F $\pm$ 5%, 25V C0G ceramic capacitors (0603) TDK C1608C0G1E103J
C26, C33	2	1000pF $\pm$ 5%, 50V C0G ceramic capacitors (0603) TDK C1608C0G1H102J
C27, C34	2	0.022 $\mu$ F $\pm$ 20%, 25V X7R ceramic capacitors (0402) TDK C1005X7R1E223K
C35	1	0.22 $\mu$ F $\pm$ 10%, 6.3V X5R ceramic capacitor (0402) TDK C1005X5R0J224K
C36, C81	0	Not installed, capacitors (0603)
C40–C51, C75, C83, C84, C85, C87, C89, C91, C92	20	0.1 $\mu$ F $\pm$ 10%, 10V X5R ceramic capacitors (0402) TDK C1005X5R1A104K

DESIGNATION	QTY	DESCRIPTION
C52, C56, C60, C64, C82	5	220 $\mu$ F $\pm$ 20%, 6.3V tantalum capacitors (C-case) AVX TPSC227M006R0250 or AVX TPSC227M006R0100
C53, C57, C61, C93	0	Not installed, capacitors (C-case)
C54, C58, C62, C65, C67, C70, C73, C79	8	10 $\mu$ F $\pm$ 20%, 6.3V X5R ceramic capacitors (0805) TDK C2012X5R0J106M
J1	1	Stereo headphone jack (3.5mm diameter)
J2, J3	2	Phono jacks (side-entry PCB mount) yellow
J4	1	Phono jack (side-entry PCB mount) black
J5	1	SMA PC-mount connector
J6	0	Not installed, jumper
J7	1	2 x 10 right-angle female receptacle
J8, J9	2	Phono jacks (side-entry PCB mount) white
JU1	1	Jumper, dual-row, 28-pin header
JU2–JU8	7	Jumpers, 2-pin headers
L1, L2	2	3.3 $\mu$ H $\pm$ 10%, 270mA inductors (1812) Coilcraft 1812CS-332XKB
R1, R2, R17, R18, R19, R22	0	Not installed, resistors (0603)
R4, R8	2	75 $\Omega$ $\pm$ 5% resistors (0603)
R5, R9	2	4.7k $\Omega$ $\pm$ 5% resistors (0603)
R6, R10, R12, R15	4	47k $\Omega$ $\pm$ 5% resistors (0603)
R7, R11	2	3.01k $\Omega$ $\pm$ 1% resistors (0603)
R13	1	243 $\Omega$ $\pm$ 1% resistor (0603)
R14	1	107 $\Omega$ $\pm$ 1% resistor (0603)
R16	1	0 $\Omega$ $\pm$ 5% resistor (1206)
R20, R23	2	10k $\Omega$ $\pm$ 5% resistors (0603)
R21	1	2.4k $\Omega$ $\pm$ 1% resistor (0603)

# MAX9851 Evaluation Kit/Evaluation System

## Component List (continued)

DESIGNATION	QTY	DESCRIPTION
R24	1	510Ω ±5% resistor (0603)
R25, R26	2	100kΩ ±5% resistors (0603)
R27–R34	8	10kΩ ±5% resistors (0402)
R35–R38	4	0Ω ±5% resistors (0603)
T1	1	Digital audio transformer Scientific Conversion SC979-03
U1	1	Stereo audio CODEC (48-pin TQFN) 7mm x 7mm x 0.8mm Maxim MAX9851ETM
U2, U3	2	192kHz digital audio receivers (28-pin TSSOP) Cirrus Logic CS8416-CZ
U4	1	192kHz digital audio transmitter (28-pin TSSOP) Cirrus Logic CS8406-CZ
U5	1	Phase-locked loop (14-pin TSSOP) Texas Instruments TLC2933IPW

μMAX is a registered trademark of Maxim Integrated Products, Inc.

DESIGNATION	QTY	DESCRIPTION
U6	1	XC9500XL series CPLD Xilinx XC9536XL-7VQ44C
U7	1	Level translator (10-pin μMAX®) Maxim MAX1840EUB
U8–U13, U16	7	Dual-bit, dual-supply level translators (8-pin SSOP) Texas Instruments SN74AVC2T45DCTR
U14	1	Power-management IC (20-pin QFN) 5mm x 5mm x 0.9mm Maxim MAX1799AEGP
U15	1	I <sup>2</sup> C to parallel converter (16-pin QSOP) Maxim MAX1609EEE
Y1	1	26MHz crystal clock oscillator AVX K53-3C0-SE26
See table for jumper settings	19	Shunts
—	1	PCB: MAX9851 Evaluation Kit

**Evaluate: MAX9851**

## Component Suppliers

SUPPLIER	PHONE	FAX	WEBSITE
AVX Corp.	843-946-0238	843-626-3123	www.avxcorp.com
Coilcraft, Inc.	847-639-6400	847-639-1469	www.coilcraft.com
Scientific Conversion	415-892-2323	—	www.scientificconversion.com
TDK Corp.	847-803-6100	847-390-4405	www.component.tdk.com

**Note:** Indicate that you are using the MAX9851 when contacting these component suppliers.

# MAX9851 Evaluation Kit/Evaluation System

## Quick Start

### Recommended Equipment

- Computer running Windows 98, 2000, or XP
- Standard USB peripheral cable
- CMODUSB command module
- One 5.0V/2A DC power supply
- One pair of headphones (16Ω or greater)
- One analog audio source
- Three RCA interconnect cables

Refer to the MAX9851/MAX9853 data sheet while using this EV kit for detailed descriptions of the CODEC's features.

### Procedure

The MAX9851 EV kit is fully assembled and tested. Follow the steps below to verify board operation in an analog input, digital loopback, analog output mode. Once the board has been set up, verify that the board is operating properly before beginning an evaluation. **Do not turn on the power supply until all connections are completed.**

### Command Module Setup

- 1) Set both switches (SW1) to the 'on' position to enable the SDA/SCL pullup resistors on the command module.
- 2) Install a shunt across pins 2-3 of the VDD select jumper (J1) to set the command module working voltage to 3.3V.
- 3) To avoid damaging the EV kit or the computer, do not connect the USB cable until power has been applied to the EV kit.

### EV Kit Setup

- 1) Install a shunt on each of the following jumpers: JU4, JU5, JU6, JU7, and each row of JU1 across pins 1-2.
- 2) Connect the 5V power supply between the PMIC and AGND pads.

- 3) Carefully align the 20-pin connector of the MAX9851 EV kit with the 20-pin header of the CMODUSB interface board. Gently press them together.
- 4) Launch the INSTALL.EXE on the included CD to copy the files, install drivers for the CMODUSB board, and create icons in the Windows 98/2000/XP Start menu.
- 5) Turn on the 5.0V power supply.
- 6) Connect the USB cable between the PC USB port and the CMODUSB command module.
- 7) Start the MAX9851 program by opening its icon in the Start menu or launching the executable. Verify normal device operation by the "Status: MAX9851 Operational" text in the Interface box.

### Verification of Board Operation

- 1) Connect a single RCA cable between S/PDIF IN1 and S/PDIF OUT.
- 2) Connect a stereo analog audio source to LINEIN1 and LINEIN2.
- 3) Insert a pair of headphones into the HEADPHONE jack.
- 4) Enable the stereo audio source.
- 5) Use the auto-setup feature in the software to auto-configure the MAX9851.
- 6) Audio will output at the headphone and speaker amplifiers.
- 7) Repeat steps 1 through 5 using S/PDIF IN2.

## Detailed Description of Software

### Autosetup

Click the **Auto-Setup** button to allow the EV kit to automatically detect incoming digital signals and configure itself appropriately. The software follows the flow chart in Figure 1 during autosetup.

# MAX9851 Evaluation Kit/Evaluation System

Evaluate: MAX9851

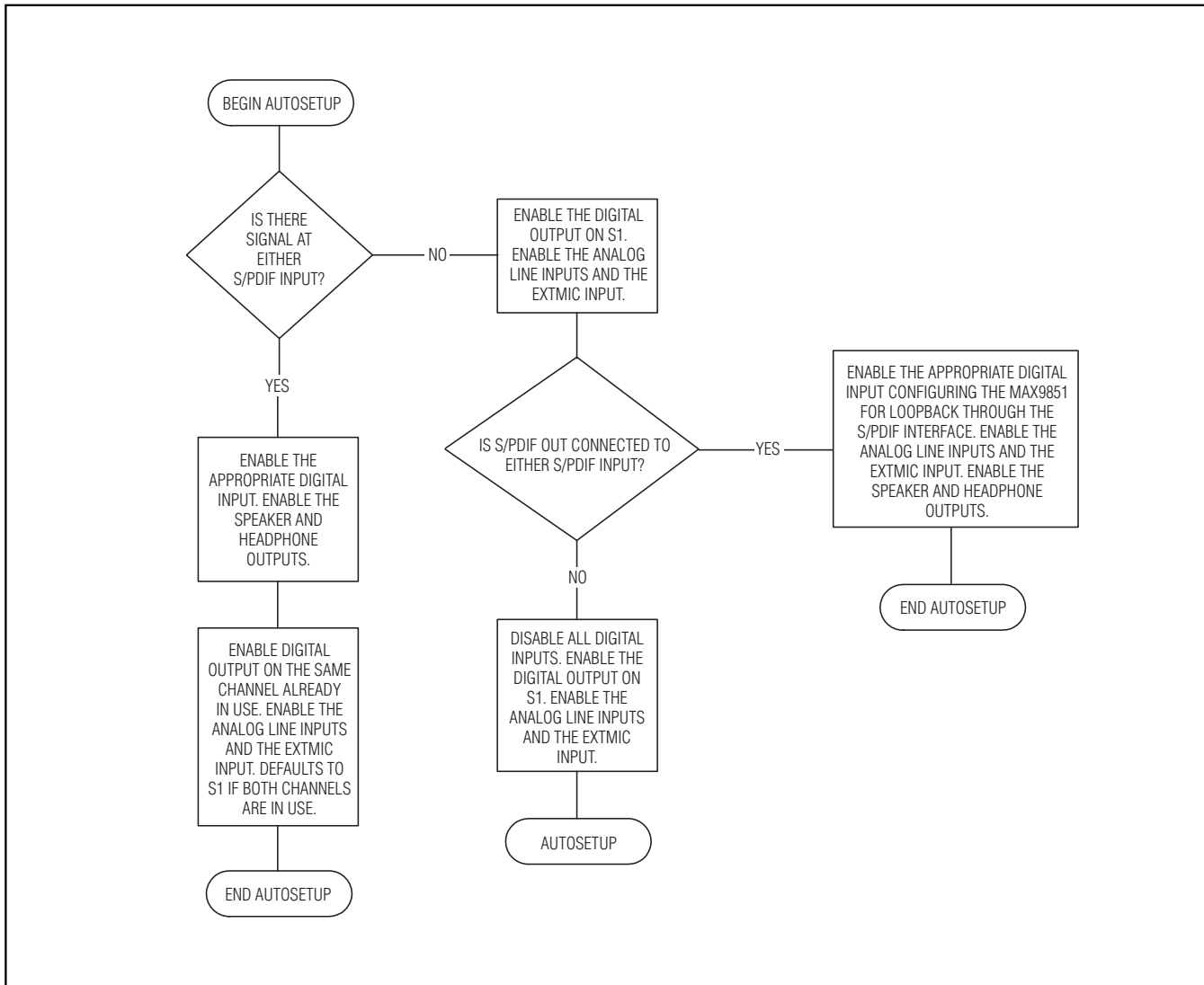

Figure 1. AutoSetup Routine Flow Chart

# MAX9851 Evaluation Kit/Evaluation System

## User-Interface Panel

The user interface (Figure 2) is easy to operate. Each interface control generates the correct I<sup>2</sup>C write operation to update the internal registers of the MAX9851 and other I<sup>2</sup>C devices on the EV kit.

## Interface

The **Interface** box (Figure 3) indicates the current status of the MAX9851 in addition to the **Register Address Sent** and **Data Sent/Received** for the last read/write operation. Use this data to confirm proper device operation.

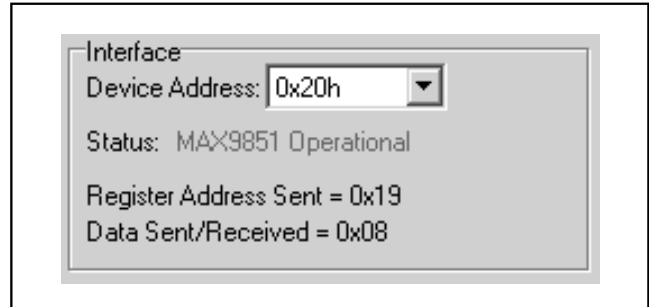

Figure 3. MAX9851 Interface Box

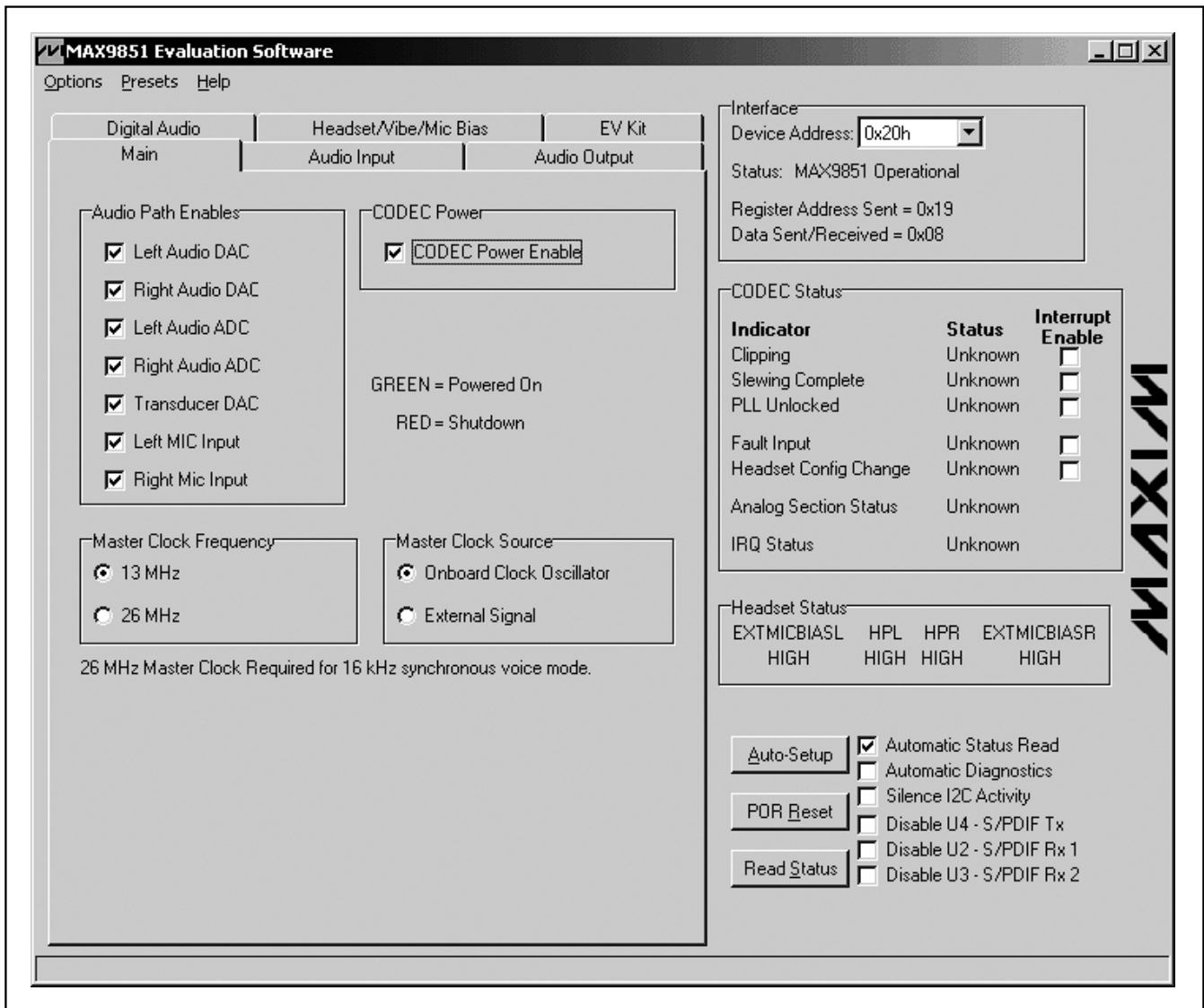

Figure 2. MAX9851 EV Kit Main Window

# MAX9851 Evaluation Kit/Evaluation System

Evaluate: MAX9851

## MAX9851 Status

The current status is reported in the **CODEC Status** box (Figure 4). The MAX9851 EV kit software defaults to a state that continually polls the device for new status data and monitors the alert conditions. Check the **Interrupt Enable** box next to the desired indicator to enable updates to the status indicator and trigger hardware interrupts when the alert condition occurs. If an interrupt is generated, the message **INTERRUPT** appears next to the IRQ status label and the program disables automatic reading of the status registers. The status of the IRQ pin can also be accessed in hardware by the IRQB pad on the EV kit.

The **Analog Section Status** must report OK for the MAX9851 to function properly. This flag is set once the MAX9851 has been brought out of shutdown, the clock input is enabled, and the charge pump is enabled.

## Headset Status

When the headset-detect feature is enabled, the impedance of each headset pin is reported in the **Headset Status** box (Figure 5). Use this information to determine the configuration of the attached headset. See the MAX9851/MAX9853 data sheet for a detailed description of the headset-detection feature.

## Software Options

Uncheck the **Automatic Status Read** checkbox to disable continuous polling of the MAX9851 status registers. Uncheck the **Automatic Diagnostics** checkbox to disable automatic checks of the command module board and the MAX9851 EV kit connectivity. Check the **Silence I<sup>2</sup>C Activity** checkbox to minimize I<sup>2</sup>C bus activity and allow easy triggering of an oscilloscope on I<sup>2</sup>C events. Clear the **Disable U4 - S/PDIF Tx**, **Disable U2 - S/PDIF Rx 1**, and **Disable - U3 S/PDIF Rx 2** checkboxes to enable the S/PDIF transmitter and each of the receivers.

Click **POR Reset** to return the EV kit to its initial power-on state. This will reset the entire EV kit to defaults and return the MAX9851 to shutdown mode. Click the **Read Status** button to force a manual status register read.

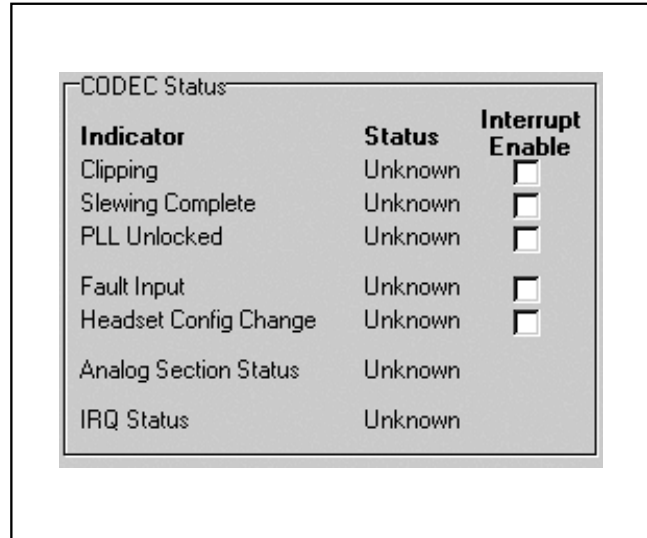

Figure 4. MAX9851 Status Box

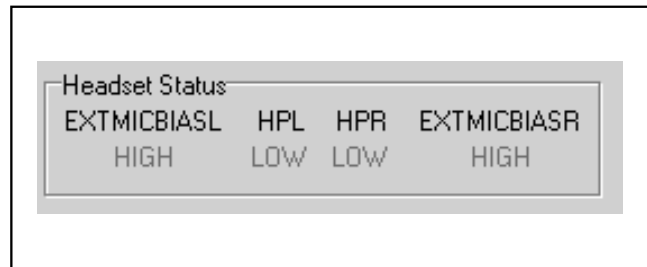

Figure 5. Headset Status Box

## Options Menu

### 2-Wire Interface Diagnostics

In addition to the main control interface, direct I<sup>2</sup>C commands can be issued to any part on the EV kit through the **2-wire interface** diagnostics available from the **Options** menu. The 2-wire interface diagnostics allow I<sup>2</sup>C operations, such as read byte and write byte, to be executed. Deselect the **Automatic Status Read** and

# MAX9851 Evaluation Kit/Evaluation System

**Automatic Diagnostics** checkboxes before using the 2-wire interface diagnostics. The I<sup>2</sup>C dialog boxes accept numeric data in binary, decimal, or hexadecimal. Hexadecimal numbers should be prefixed by \$ or 0x. Binary numbers must be exactly eight digits. See Figure 6 for an example of this control method.

### View Register Settings

Select **View Register Settings** to display the register settings of the MAX9851 (Figure 7) and optionally save them to a text file.

### Save/Load Settings

Select **Save Settings** to save the EV kit configuration to a text file that can be loaded at a later time. Select **Load Settings** to reload settings from a saved file.

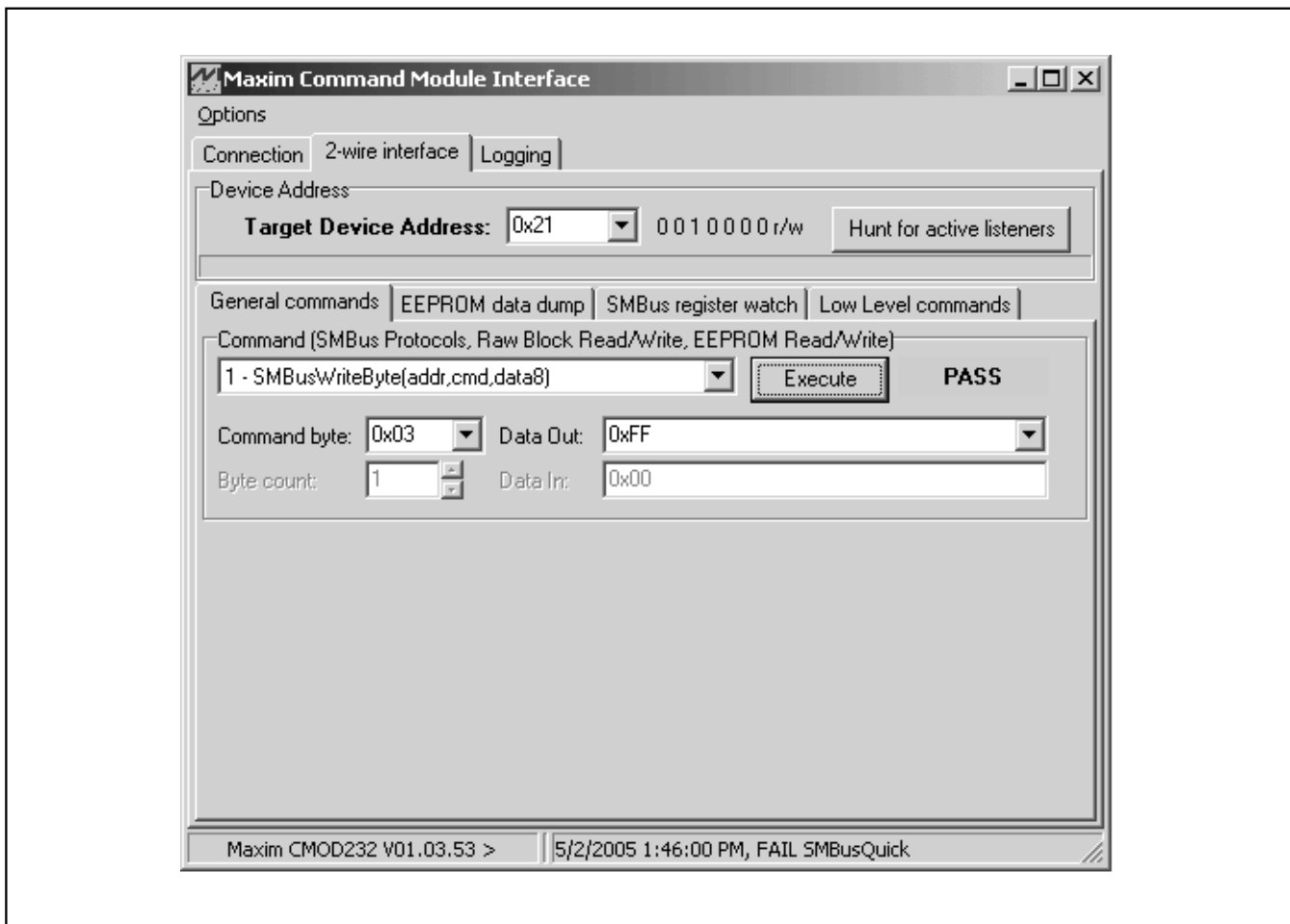

Figure 6. 2-Wire Interface Diagnostics



# MAX9851 Evaluation Kit/Evaluation System

Evaluate: MAX9851

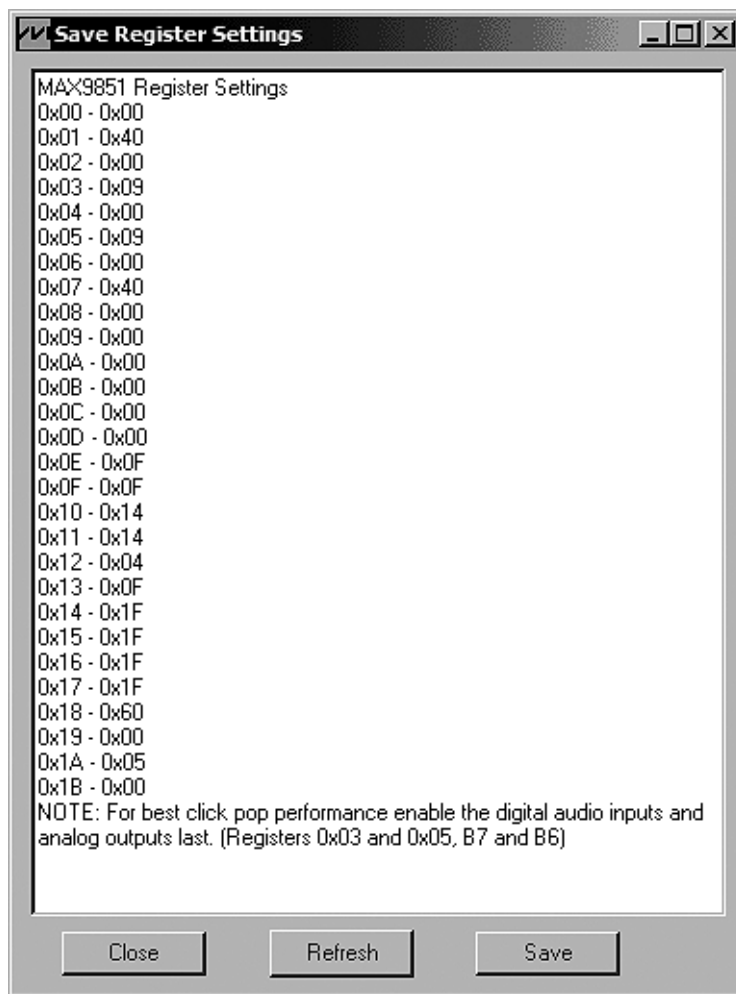

Figure 7. View Register Settings

# MAX9851 Evaluation Kit/Evaluation System

## Presets Menu

Click the **Presets** menu to access six preconfigured operating modes for the EV kit. These presets quickly configure the MAX9851 in the operating mode listed in Table 1. Once a preset has been selected, use the main interface to optimize the settings as desired.

**Table 1. EV Kit Preset Configurations**

SETTING	DESCRIPTION
48kHz Digital Audio Playback	Input: Digital audio on S1. Outputs: Stereo headphones and speakers.
48kHz Digital and Analog Audio Playback	Inputs: Digital audio on S1 and analog line inputs. Outputs: Stereo headphones and speakers.
16kHz Microphone Record	Inputs: Stereo external microphones. Outputs: Digital audio on S1.
Analog Playback	Inputs: Analog line inputs. Outputs: Stereo headphones and speakers.
48kHz Digital Audio Loopback*	Inputs: Analog line inputs. Loopback: S1 digital audio output connected to S1 input operating 48kHz stereo audio mode. Outputs: Stereo headphones and speakers.
8kHz Voice Mode Digital Loopback*	Inputs: Mono external microphone. Loopback: S1 digital audio output connected to S1 input operating in 8kHz voice mode with voiceband filtering. Outputs: Mono headphone and speaker.

\*Place a shunt between pin 2 of SDIN1 and pin 2 of SDOU1 on JU1 to complete loopback.

## Help Menu

Click **MAX9851 Help** from the Help menu to access an online version of this document.

## Main Control Options

The **Main** page (Figure 8) controls power-management options for the MAX9851 as well as clocking and oscillator options. Click **CODEC Power Enable** to bring the MAX9851 out of shutdown. Power on each DAC, ADC, and microphone input in the MAX9851 through the **Audio Path Enables** box.

Choose 13MHz and 26MHz operation from the **Master Clock Frequency** box. Choosing a frequency adjusts the EV kit multiplexers to route the appropriate on-board oscillator frequency to the MAX9851. Click **External Signal** from the **Master Clock Source** box to supply an external clock signal through the on-board SMA connector J5. The supplied clock must match the frequency selected in the **Master Clock Frequency** box.

Using the 2-wire interface diagnostics, the master clock can be disabled (refer to the MAX9851/MAX9853 data sheet for details).

## Audio Input Control Options

The MAX9851 features extensive signal routing and gain adjustment for all inputs. To simplify operation, each input on the audio input page (Figure 9) is configured as a stereo pair. For complete details on all possible signal routing options, refer to the MAX9851/MAX9853 data sheet.

Click **Interface S1** or **Interface S2** to allow the incoming digital data on that interface to be routed to the stereo DAC. Ensure the interface is properly configured on the serial interfaces page. Both interfaces can be simultaneously routed to the stereo DAC regardless of sample rate.

Click **Line Inputs** to connect the line inputs to the ADC. Line input 1 is connected as left and line input 2 is connected as right. Click **Microphone Inputs** to connect the microphone interface to the ADC. By default when the internal mono microphone is selected, it is connected to both the left and right ADC input. Use the 2-wire interface diagnostics to change the default configuration.

Click **INTMIC** or **EXTMICL+R** to choose between the two microphone interfaces on the MAX9851. EXTMICL+R is a stereo single-ended microphone input intended for use with headset microphones. INTMIC is a mono differential microphone input intended for use with an electret microphone. Click **Mute** to mute the microphone interface.

Move the **S1** or **S2** fader to adjust the gain of the incoming digital signals prior to conversion by the DAC. Move the **Line In 1** or **Line In 2** slider to adjust the gain of the analog line inputs. Move the **Mic L** or **Mic R** slider to adjust the gain of the microphone inputs. Click **+20dB** for either microphone channel to boost the input signal by 20dB in addition to the gain selected by the slider. Uncheck **Track Left/Right** to allow the gain sliders of the left and right microphone inputs to be adjusted independently.

# MAX9851 Evaluation Kit/Evaluation System

Evaluate: MAX9851

Digital Audio	Headset/Vibe/Mic Bias	EV Kit
Main	Audio Input	Audio Output
<b>Audio Path Enables</b> <ul style="list-style-type: none"><li><input checked="" type="checkbox"/> Left Audio DAC</li><li><input checked="" type="checkbox"/> Right Audio DAC</li><li><input checked="" type="checkbox"/> Left Audio ADC</li><li><input checked="" type="checkbox"/> Right Audio ADC</li><li><input checked="" type="checkbox"/> Transducer DAC</li><li><input checked="" type="checkbox"/> Left MIC Input</li><li><input checked="" type="checkbox"/> Right Mic Input</li></ul>		<b>CODEC Power</b> <ul style="list-style-type: none"><li><input checked="" type="checkbox"/> CODEC Power Enable</li></ul>
<b>Master Clock Frequency</b> <ul style="list-style-type: none"><li><input checked="" type="radio"/> 13 MHz</li><li><input type="radio"/> 26 MHz</li></ul>		<b>Master Clock Source</b> <ul style="list-style-type: none"><li><input checked="" type="radio"/> Onboard Clock Oscillator</li><li><input type="radio"/> External Signal</li></ul>
26 MHz Master Clock Required for 16 kHz synchronous voice mode.		

Figure 8. MAX9851 EV Kit Main Control Page

# MAX9851 Evaluation Kit/Evaluation System

Evaluate: MAX9851

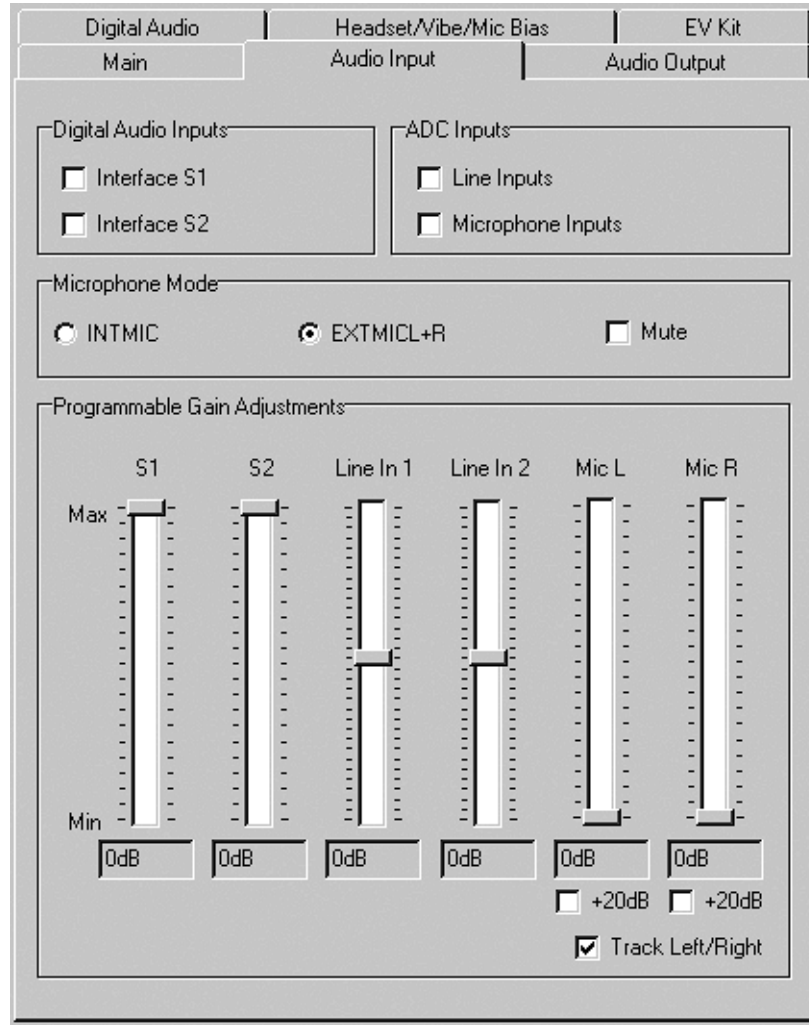

Figure 9. MAX9851 EV Kit Audio Input Control Page

# MAX9851 Evaluation Kit/Evaluation System

## Audio Output Control Options

The MAX9851 features extensive routing options for the analog output stage. To simplify operation, each output on the audio output page (Figure 10) is configured as a stereo pair. For complete details on all possible signal routing options refer to the MAX9851/MAX9853 data sheet.

Click **Line Inputs**, **Sidetone**, or **DAC Output** to connect a source to the analog output stage consisting of the headphone, receiver, and speaker amplifiers. Move the **Sidetone** slider to adjust the volume of the sidetone signal before it is mixed with other inputs. Move the **HPL / REC** and **HPR / REC** sliders to adjust the volume of the headphone or receiver amplifier output, depending which has been enabled. Uncheck **Track Left/Right** to adjust the volume sliders independently. Click **Mute** to mute the headphone or receiver amplifier outputs.

Move the **SPK L** and **SPK R** sliders to adjust the volume of the speaker amplifiers. Uncheck **Track Left/Right** to adjust the volume sliders independently. Click **Mute** to mute the speaker amplifiers.

Check **Smooth Volume Changes** to enable stepping of all volume changes through intermediate values. Uncheck **Smooth Volume Changes** to make volume changes step from the initial value directly to the final value. Check **Volume Changes at zero-crossing only** to force all volume changes to be made at zero-crossings in the signal waveform to prevent unwanted noise.

Select **Stereo** from the **Speaker Amplifier Mode** drop-down menu to enable the stereo speaker amplifiers. Alternatively select **Right** or **Left** to independently enable the speaker amplifiers.

Select **Stereo Headphone** from the **Headphone / Receiver Output** drop-down menu to enable the headphone amplifier in stereo mode. Alternatively select **Mono Headphone** to enable the left channel only or select **Balanced Mono Headphone** to create a mono output using both headphone amplifiers as a bridged load output. Select **Receiver Amplifier** to disable the headphone amplifier and enable the mono receiver amplifier.

## Digital Audio Control Options

The digital audio page contains options for the MAX9851's two serial digital audio interfaces. The controls are split into two subtabs.

## Serial Interfaces

The serial interfaces page (Figure 11) controls settings for the primary audio interface (S1) on the top half and settings for the secondary (S2) on the bottom half. Changing audio interface settings automatically reconfigures the S/PDIF receivers and transmitter appropriately.

Check **Output Enable** for either S1 or S2 to begin transmitting data from the stereo ADC to the S/PDIF transmitter. Enabling both the S1 and S2 outputs connects the S/PDIF transmitter to the S1 data stream, as in this configuration both interfaces must output the same data.

Check **Input Enable** for either S1 or S2 to allow audio data to be sent to the corresponding interface. Make all configuration changes before enabling the input to ensure proper soft-start of the DACs. Similarly, disable the input before making changes to the interface configuration.

Check **DAC Mono Mix** to combine incoming stereo data into a left mono channel prior to conversion.

Choose a sample rate from the **Interface Sample Rate** drop-down menu to configure the corresponding MAX9851 audio interface to operate at a specific sample rate. Both stereo audio modes and voice modes can be chosen. When the 16kHz voice mode is chosen, a 26MHz master clock must be chosen from the main control page. When both the S1 and S2 audio interface outputs are enabled, both interfaces must operate at the same sample rate as configured by the S1 interface sample-rate control. In all other modes, the two interfaces can operate at different sample rates. Although the voice interface modes are available on both S1 and S2, only S1 offers built-in voiceband filtering of incoming data.

Check the **Invert** checkbox below **LRCLK** or **BCLK** to invert the waveform of the LRCLK or BCLK clock line on the particular interface. Check **Delay** below **Data** to delay audio data one BCLK cycle.

Choose **Master** mode from the **Data Control** drop-down menu to configure the corresponding interface to operate as a digital audio master and generate the necessary LRCLK and BCLK clock signals internally. Select **Slave** to allow the S/PDIF receivers or transmitter to provide the LRCLK and BCLK signals.

Select **16 Bit** from the **Word Size** drop-down menu to configure the corresponding interface to accept and transmit 16-bit data. Select **18 Bit** for increased bit depth. When operating in 18-bit mode, the S/PDIF receivers and transmitter operate in 24-bit mode.

# MAX9851 Evaluation Kit/Evaluation System

Evaluate: MAX9851

Digital Audio	Headset/Vibe/Mic Bias	EV Kit
Main	Audio Input	Audio Output

Headphone and Speaker Amplifier Sources

Line Inputs       Sidetone       DAC Output

Audio Output Volume

Sidetone	HPL / REC	HPR / REC	SPK L	SPK R
Max				
Min				
0dB	-42dB	-42dB	-34.4dB	-34.4dB
<input type="checkbox"/> Track Left/Right	<input checked="" type="checkbox"/> Track Left/Right	<input checked="" type="checkbox"/> Track Left/Right	<input checked="" type="checkbox"/> Track Left/Right	<input checked="" type="checkbox"/> Track Left/Right
<input type="checkbox"/> Mute	<input type="checkbox"/> Mute	<input type="checkbox"/> Mute	<input type="checkbox"/> Mute	<input type="checkbox"/> Mute

Audio Output Control

Smooth Volume Changes       Volume Changes at zero-crossings only

Speaker Amplifier Mode      Headphone / Receiver Output

Shutdown      Shutdown

Figure 10. MAX9851 EV Kit Audio Output Control Page

# MAX9851 Evaluation Kit/Evaluation System

Evaluate: MAX9851

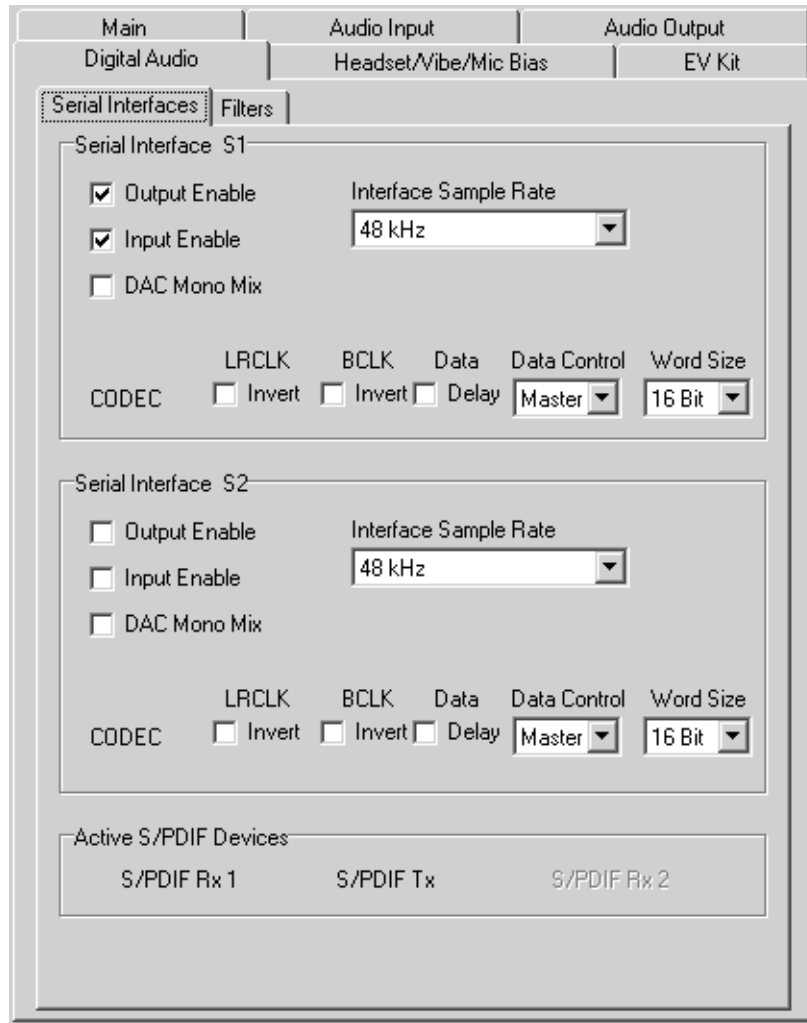

Figure 11. MAX9851 EV Kit Digital Audio—Serial Interface Control Page

# MAX9851 Evaluation Kit/Evaluation System

## Filters

The filters page (Figure 12) controls all configurable ADC and DAC filters including the voiceband filters.

Click **Block DC on the ADC signal path** to enable the built-in DC block for both ADC channels. Click **Filter ADC output using the voice-band filter** to enable the voiceband filter on the ADC output. Click **Filter DAC input data from S1 using the voice-band filter** to enable the voiceband filter on the DAC input. Both voiceband filters only operate when the S1 interface has been configured for 8kHz or 16kHz voice mode.

Choose a corner frequency range for the left and right channels of the DAC from the **DAC High-Pass Filter Mode** box to enable highpass filtering of the DAC signals.

## Headset/Vibe/Mic Bias Control Options

The headset/vibe/mic bias control page (Figure 13) controls the remaining MAX9851 features.

Click **Enable** in the **Headset Detection** section to activate the headset-detection circuitry. Enabling the headset-detection circuitry automatically disables the headphones, enables the microphones, and enables the microphone bias to ensure proper headset detection. Uncheck **Enable** to disable the headset-detection circuitry and restore the headphone and microphone circuits to their previous settings. Click **Sleep Mode** to force the headset-detection circuitry to operate in sleep mode for detecting the insertion and removal of a headset. Click the **Headphone Test Mode** drop-down menu to select the desired headphone detection mode. Refer to the MAX9851/MAX9853 data sheet for a complete explanation of headset detection.

Click the **VIBE Output** drop-down menu to select one of the four vibe signal types. Click the **VIBE DAC Path** drop-down menu to select between S1 and S2 digital-audio source data. Move the **VIBE Squelch Comparator Threshold** slider to adjust the threshold used by the inverted comparator option. Move the **VIBE Gain** slider to adjust the vibe circuitry input gain.

Select between **2.2 kOhms** and **470 Ohms** in the **Mic Bias Output Impedance** box to adjust the output impedance of EXTMICBIASL and EXTMICBIASR. Click **Enable Resistor Bias** to enable the internal resistor bias connected to EXTMICBIASL and EXTMICBIASR.

## EV Kit Control Options

The EV kit control page contains three subtabs that access the functions of the power- management and S/PDIF-support components on the MAX9851 EV kit.

### Power Management Control Options

The power management page (Figure 14) controls the MAX1799 power-management IC on the EV kit. Move the **DVCC** slider to adjust the supply voltage for DVDD and DVDDS2 on the MAX9851. Move the **AVCC** slider to adjust the supply voltage for AVDD and CPVDD on the MAX9851.

### S/PDIF Input Control Options

Two identical subtabs (Figure 15) control the two on-board S/PDIF receivers. Select a deemphasis filter setting from the **Receiver De-Emphasis Filter** box. Leave this setting disabled unless specifically needed. Select an option from the **Audio Error Handling** box to configure how the receiver handles missing samples. Monitor errors in the S/PDIF receiver at the **Receiver Error Status** box. Check the **Monitor** box next to each error condition to enable reporting. Click **Read Status** to update the error status indicators.

Obtain information about the receiver and the incoming S/PDIF data stream through the **Status** box. Click **Read Status** to update the fields in the status box. The **PCM Data** bit should always be reported as set when a valid S/PDIF signal is connected. The **Digital Silence** bit should be reported as set whenever a valid signal containing no data is connected to the receiver.

Click **Mute Receiver Output** to mute the digital output connected to the MAX9851. Click **Automatic Read** to have the software automatically update the error and status screens every time the EV kit is polled by the software. The **Automatic Diagnostics** box must also be checked for this to function properly.

### Troubleshooting

The MAX9851 software automatically searches for the CMODUSB interface board during startup. The message shown in Figure 16 is shown if the interface board is not found. Click **No** to start using the software without connecting to the hardware or check the connections and click **Yes**.

The EV kit software searches for all the required I<sup>2</sup>C devices. Any missing I<sup>2</sup>C devices are reported in a message window (Figure 17). The power-on-reset routine is automatically performed as long as the MAX9851 has been detected.



# MAX9851 Evaluation Kit/Evaluation System

Evaluate: MAX9851

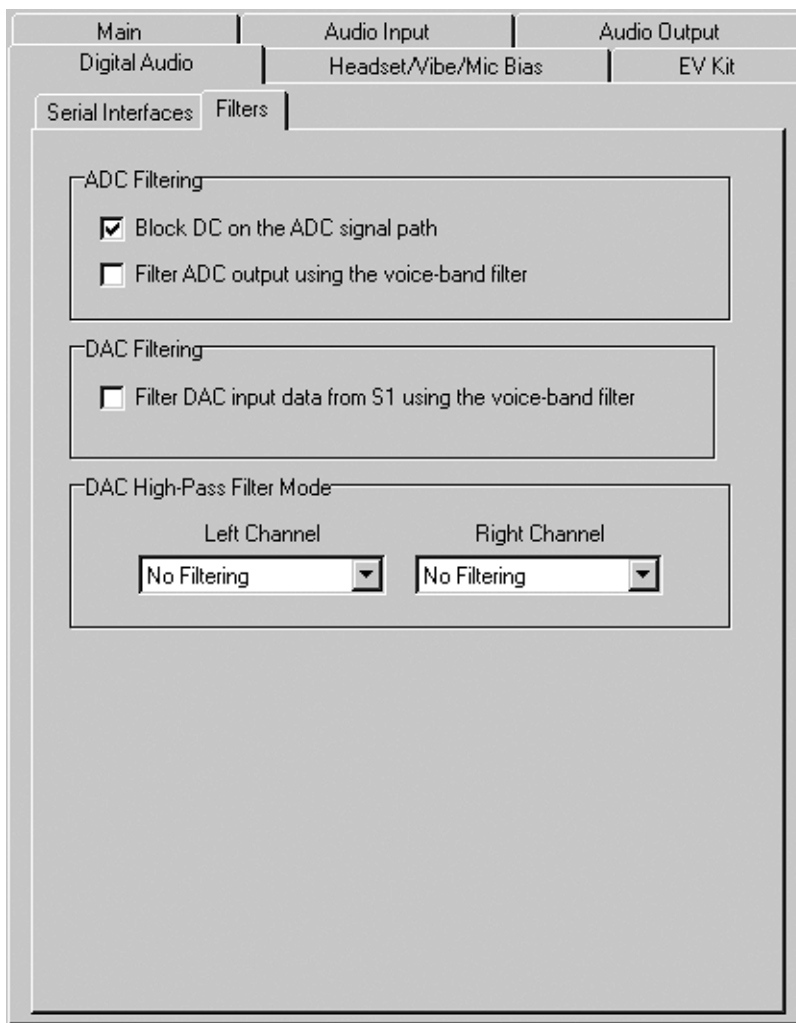

Figure 12. MAX9851 EV Kit Digital Audio—Filter Control Page

# MAX9851 Evaluation Kit/Evaluation System

Evaluate: MAX9851

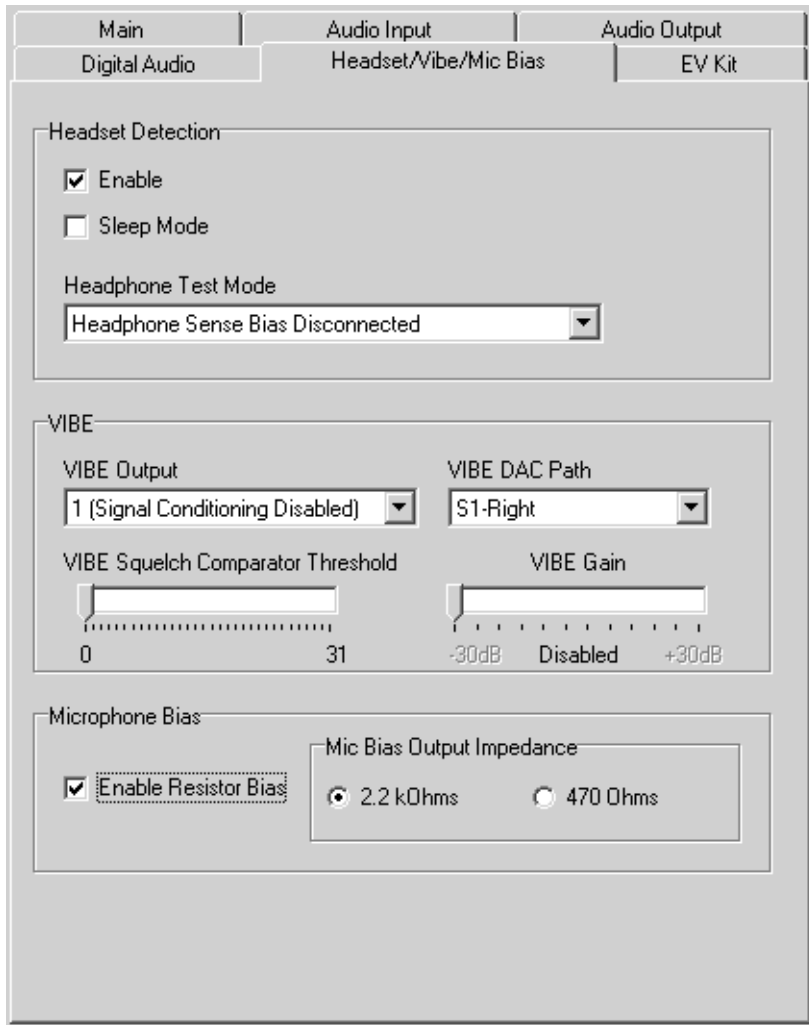

Figure 13. MAX9851 EV Kit Headset/Vibe/Mic Bias Control Page

# MAX9851 Evaluation Kit/Evaluation System

Evaluate: MAX9851

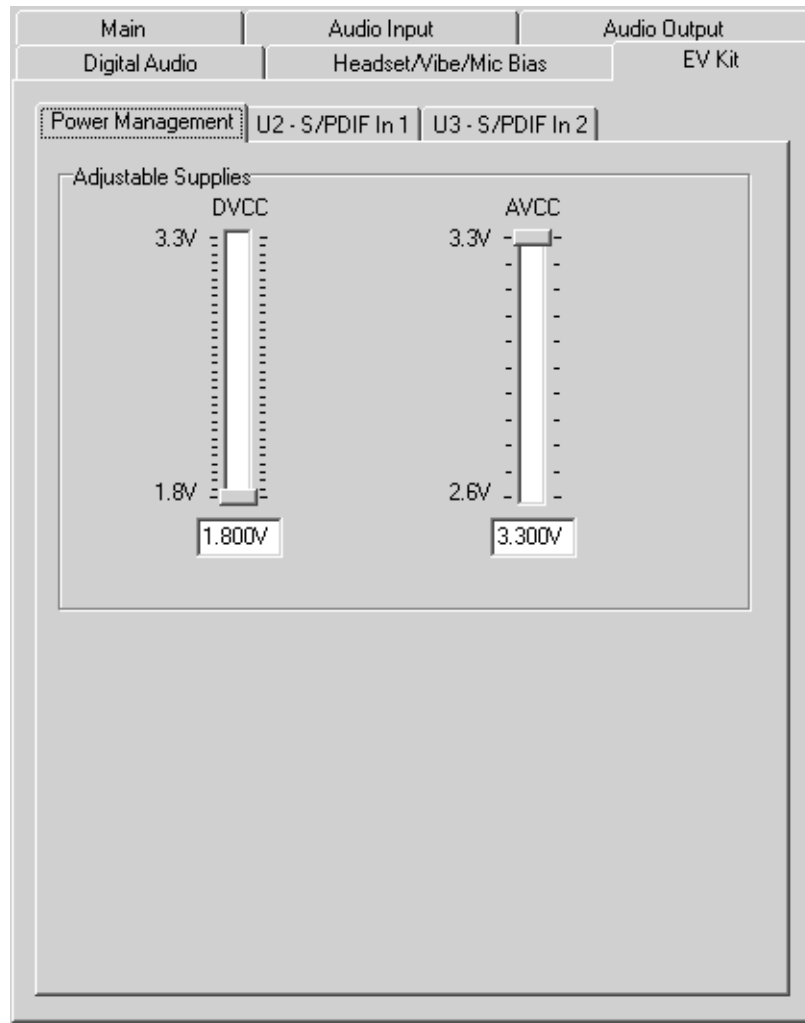

Figure 14. MAX9851 EV Kit Power Management Page

# MAX9851 Evaluation Kit/Evaluation System

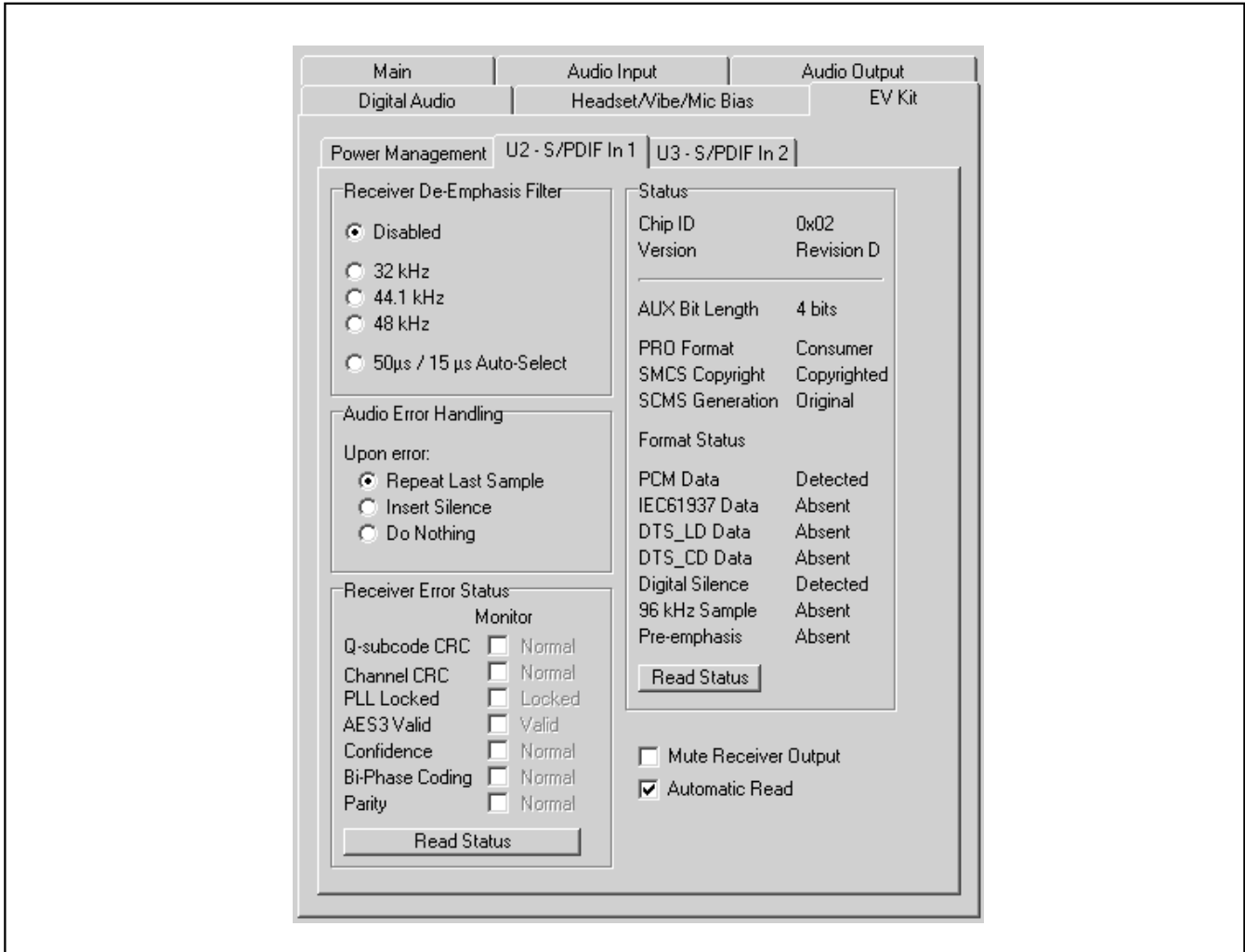

Figure 15. MAX9851 EV Kit S/PDIF Input Control Pages

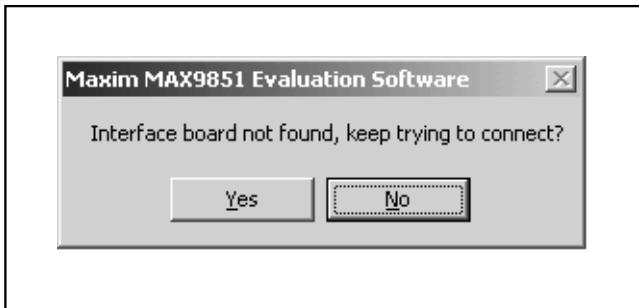

Figure 16. Interface Board Not Found Message Box



Figure 17. Message Box that Indicates Missing I<sup>2</sup>C Devices

# MAX9851 Evaluation Kit/Evaluation System

## Hardware Description

The MAX9851 EV kit is a complete digital-audio evaluation system for the MAX9851 audio CODEC. The portion of the EV kit required to operate the MAX9851 is shown in Figure 18. All additional components are included to aid evaluations.

In addition to providing access to all MAX9851 audio inputs and outputs, the EV kit provides translation of the

on-board serial digital-audio signals to coaxial S/PDIF signals to allow easy connection with consumer electronics devices.

Access the S/PDIF inputs through RCA connectors at J2 and J3. Access the S/PDIF output through the RCA connector at J4. All S/PDIF connections function for sample rates from 32kHz to 48kHz. To transmit lower sample rates, connect a serial audio transmitter or receiver directly to the MAX9851.

Evaluate: MAX9851

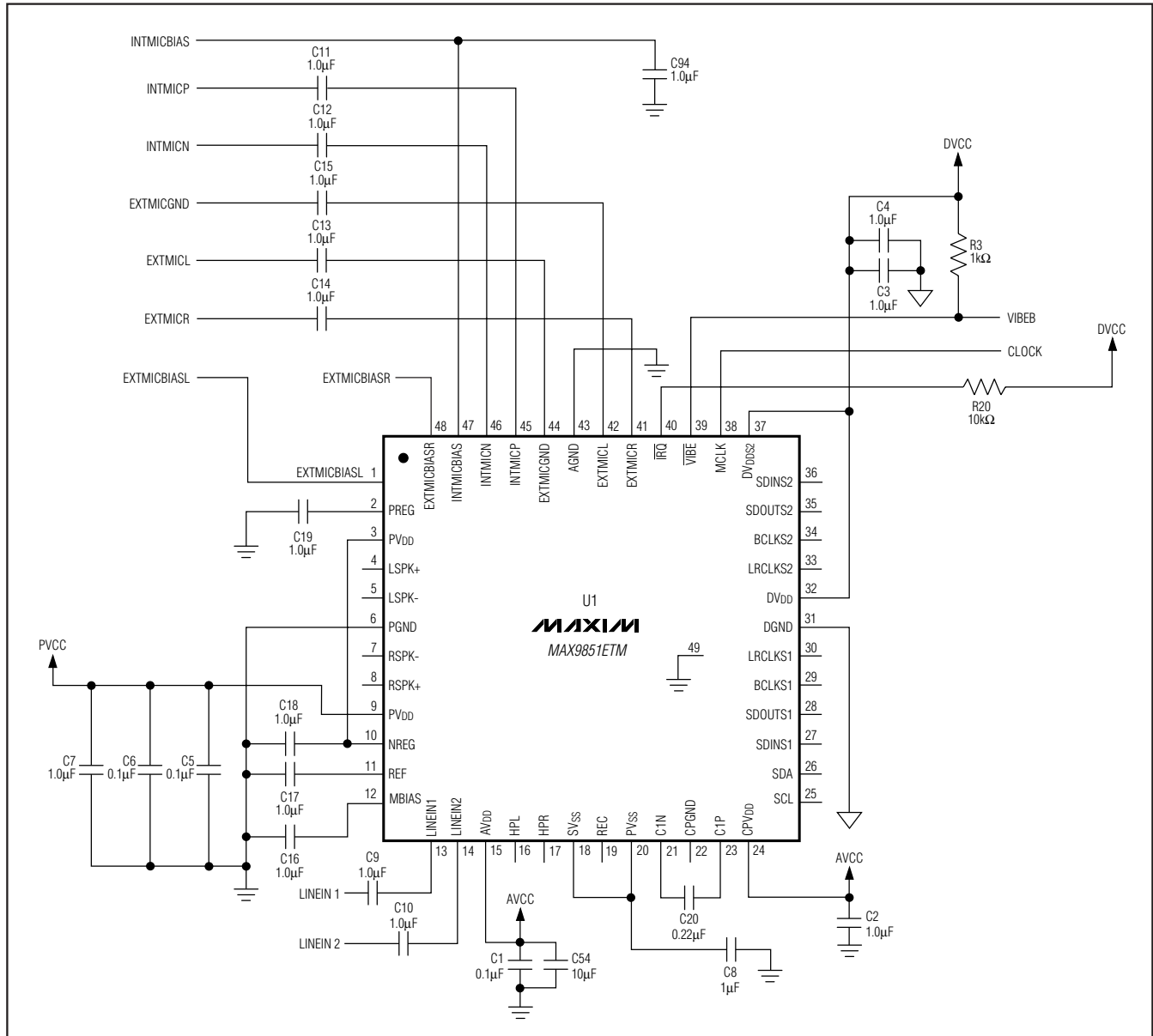

Figure 18. Minimum Required EV Kit Components

# MAX9851 Evaluation Kit/Evaluation System

Access the analog line inputs through RCA connectors at J8 and J9. Connect headphones to the DirectDrive headphone output of the MAX9851 through the 3.5mm headphone jack J1.

The remaining inputs and outputs of the MAX9851 are accessible through pads on the right and bottom sides of the EV kit.

See Table 2 for a description of all EV kit shunt configurations.

### Power Management

The power-management IC (MAX1799) generates the necessary voltages for the MAX9851 EV kit. Connect a 5V supply to the PMIC pad to power the power-management IC. Remove the shunts from JU4 through JU8 to power the on-board supplies externally. The supply voltages of the EV kit can then be externally supplied and controlled. See Table 3 for a listing of each EV kit supply.

### Differential (Internal) Microphone Connection

R1 and R2 provide microphone bias connections for the internal differential microphone input. Populate R1 and R2 with 2.2k $\Omega$  resistors to provide microphone bias.

### Stereo (External) Microphone Connection

JU2 and JU3 connect EXTMICR and EXTMICL to EXTMICBIASR and EXTMICBIASL, respectively. Enable the resistor bias option on the headset/vibe/mic bias-control page of the software to provide microphone bias once JU2 and JU3 are installed. Use the EXTMICGND pin for the ground connection of all microphones connected to this interface.

Table 2. EV Kit Shunts

SHUNT	DEFAULT SETTING	DESCRIPTION
JU1	1-2, all rows	Digital I/O isolation header.
JU2	Open	Connects EXTMICR to EXTMICBIASR to provide microphone bias.
JU3	Open	Connects EXTMICL to EXTMICBIASL to provide microphone bias.
JU4	Closed	Connects the MAX1799 to V <sub>MOD</sub> .
JU5	Closed	Connects the MAX1799 to DV <sub>CC</sub> .
JU6	Closed	Connects the MAX1799 to V <sub>VCO</sub> .
JU7	Closed	Connects the MAX1799 to AV <sub>CC</sub> .
JU8	Closed	Connects the PMIC supply to PV <sub>CC</sub> .

Table 3. EV Kit Supplies

EV KIT SUPPLY	DESCRIPTION
PMIC	3.5V to 5.5V supply that powers the MAX1799.
V <sub>MOD</sub>	3.3V supply that powers U2, U3, U4, U6, and U15.
DV <sub>CC</sub>	1.7V to 3.6V supply that powers DV <sub>DD</sub> and DV <sub>DDS2</sub> on the MAX9851 and seven level translators. At 1.8V the level translators draw a combined current of 22 $\mu$ A.
AV <sub>CC</sub>	2.6V to 3.6V supply that powers AV <sub>DD</sub> and CPV <sub>DD</sub> on the MAX9851.
V <sub>VCO</sub>	3.3V supply that powers the on-board VCO (U5) used in generating clock signals for the S/PDIF transmitter.
PV <sub>CC</sub>	2.6V to 5.5V supply that powers PV <sub>DD</sub> on the MAX9851.

# MAX9851 Evaluation Kit/Evaluation System

Evaluate: MAX9851

## Control and Data Interface

JU1 connects the MAX9851 digital I/O pins to the rest of the EV kit. For normal operation install a shunt between pins 1 and 2 of each row of JU1 (Figure 19). Remove shunts as necessary to connect equipment or other components directly to the MAX9851. Pin 3 of rows 2 through 14 provides a clean connection to the digital ground plane of the EV kit for grounding test leads.

Place a shunt between pin 2 of SDIN1 and pin 2 of SDOUT1 to place the primary digital-audio interface in loopback mode. This process routes data from the ADC directly back into the DAC for testing purposes. Place a shunt between pin 2 of SDIN2 and pin 2 of SDOUT2 to place the secondary digital-audio interface in loopback mode.

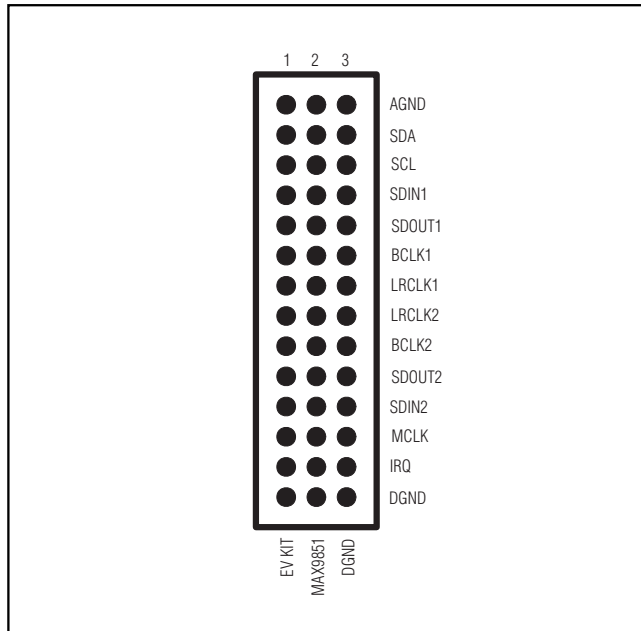

Figure 19. Header JU1

## Clocking

### Internal

The MAX9851 EV kit features an on-board 26MHz crystal oscillator to provide the necessary master clock for the MAX9851. To create the necessary 13MHz and 26MHz clock signals, the on-board oscillator is divided by 2, creating a 13MHz clock when needed.

### External

Connect an external clock source to the SMA connector J5 to drive MAX9851's MCLK pin without using the on-board oscillator. When using an external clock, the external signal option must be selected on the main control page of the EV kit software. Configure the master clock frequency option on the main control page to match the supplied clock frequency. Populate R17 and C81 as appropriate to provide termination for the incoming signal.

## Using an Alternative I<sup>2</sup>C Interface

Connect an I<sup>2</sup>C master to the SDA and SCL pads of the MAX9851 EV kit to communicate with the I<sup>2</sup>C parts without using the command module. Install 10kΩ pullup resistors at positions R18 and R19 on the back side of the board if required. See Table 4 to determine the I<sup>2</sup>C address of each device on the EV kit. All I<sup>2</sup>C addresses are fixed in hardware.

Table 4. I<sup>2</sup>C Addresses

DEVICE	I <sup>2</sup> C ADDRESS [BINARY (HEXADECIMAL)]
MAX9851 (U1)	0010 000Y (0x20)
MAX1799 (U14)	0111 111Y (0x7E)
MAX1609 (U15)	0100 100Y (0x48)
CS8416 (U2)	0010 010Y (0x24)
CS8416 (U3)	0010 100Y (0x28)
CS8406 (U4)	0010 011Y (0x26)

**Note:** The first 7 bits shown are the address. Y (bit 0) is the I<sup>2</sup>C read/write bit. This bit is a 1 for read operations and 0 for write operations.

# MAX9851 Evaluation Kit/Evaluation System

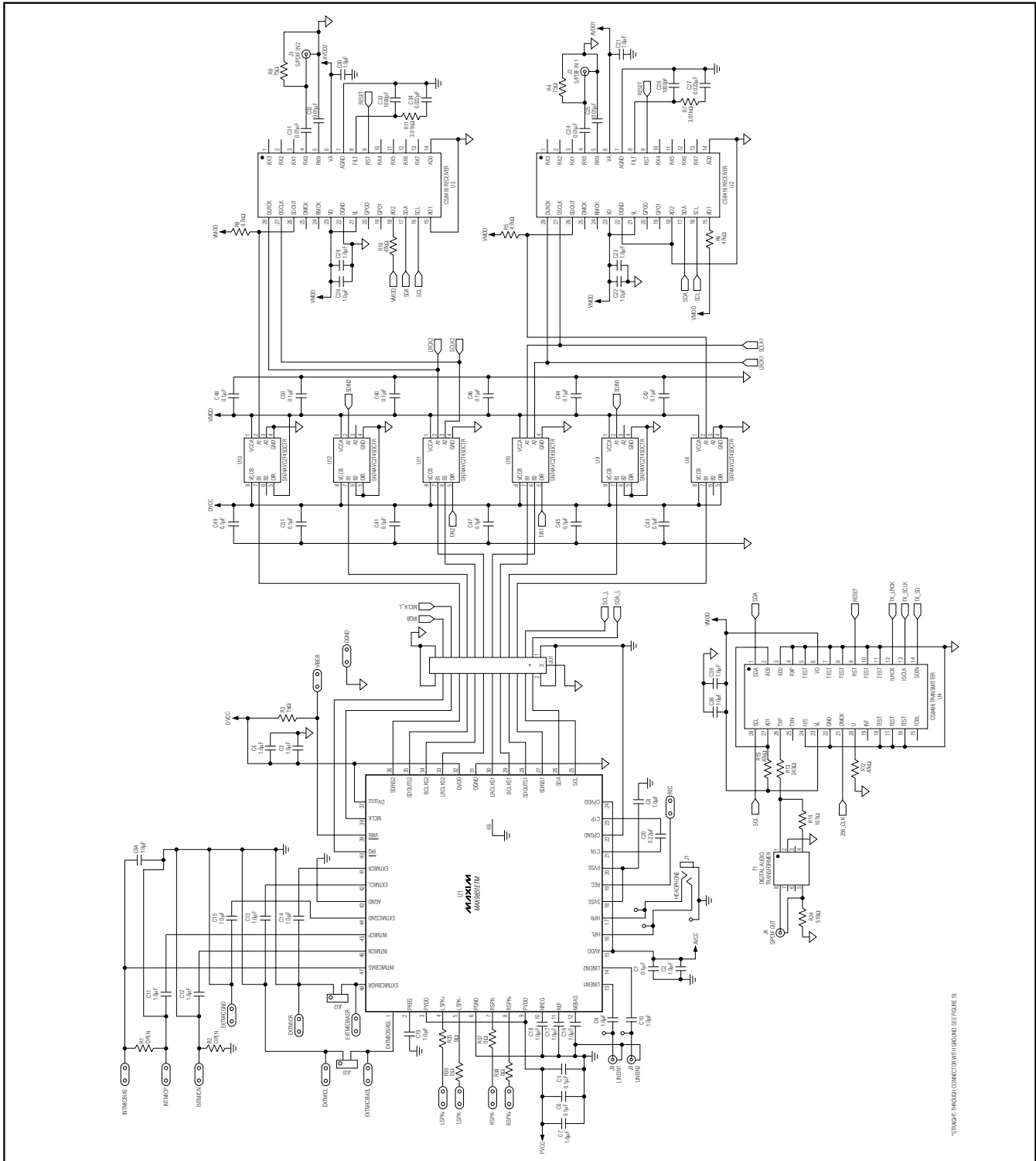

Figure 20. MAX9851 EV Kit Schematic (Sheet 1 of 3)



# MAX9851 Evaluation Kit/Evaluation System

Evaluate: MAX9851

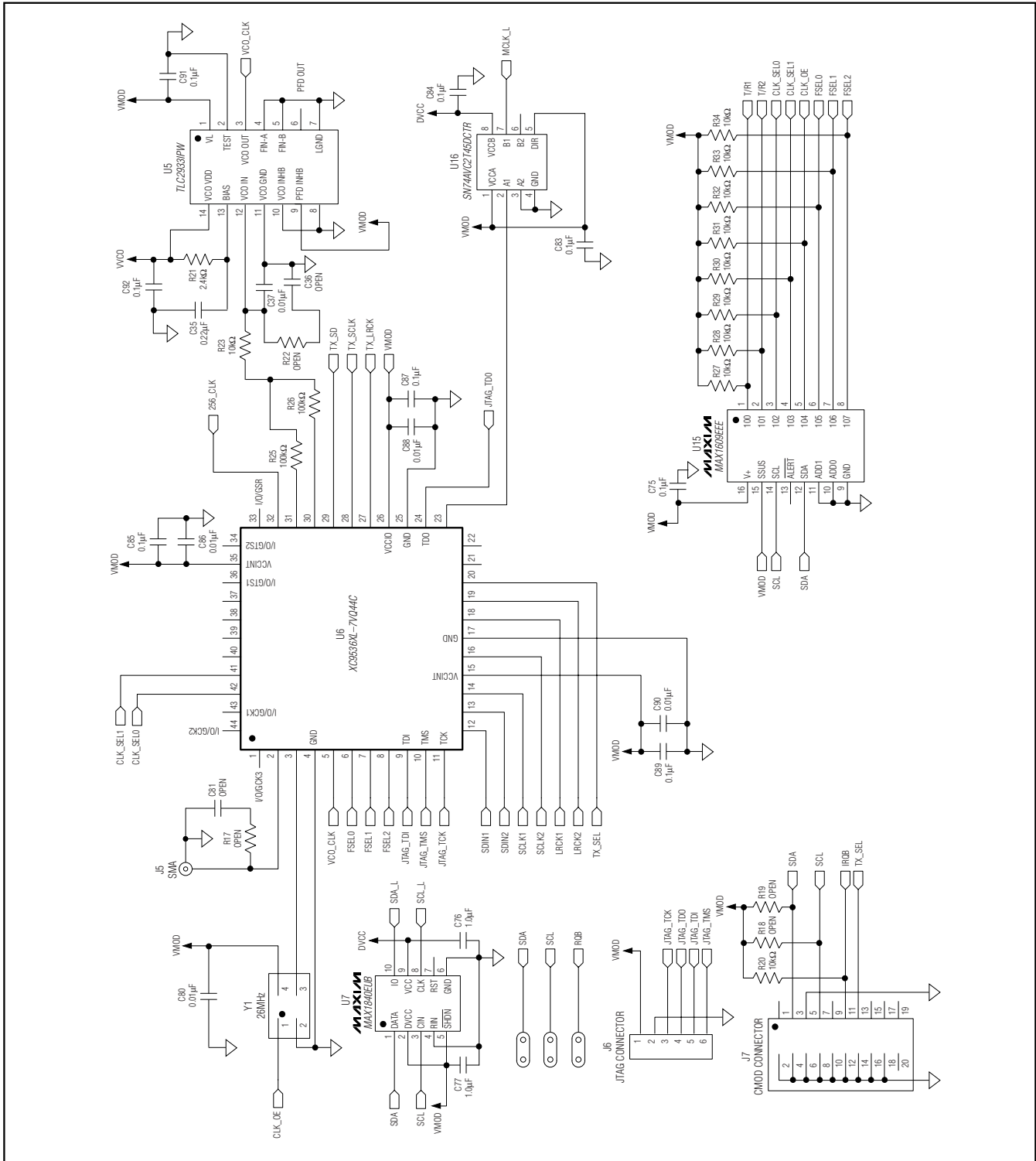

Figure 21. MAX9851 EV Kit Schematic (Sheet 2 of 3)

# MAX9851 Evaluation Kit/Evaluation System

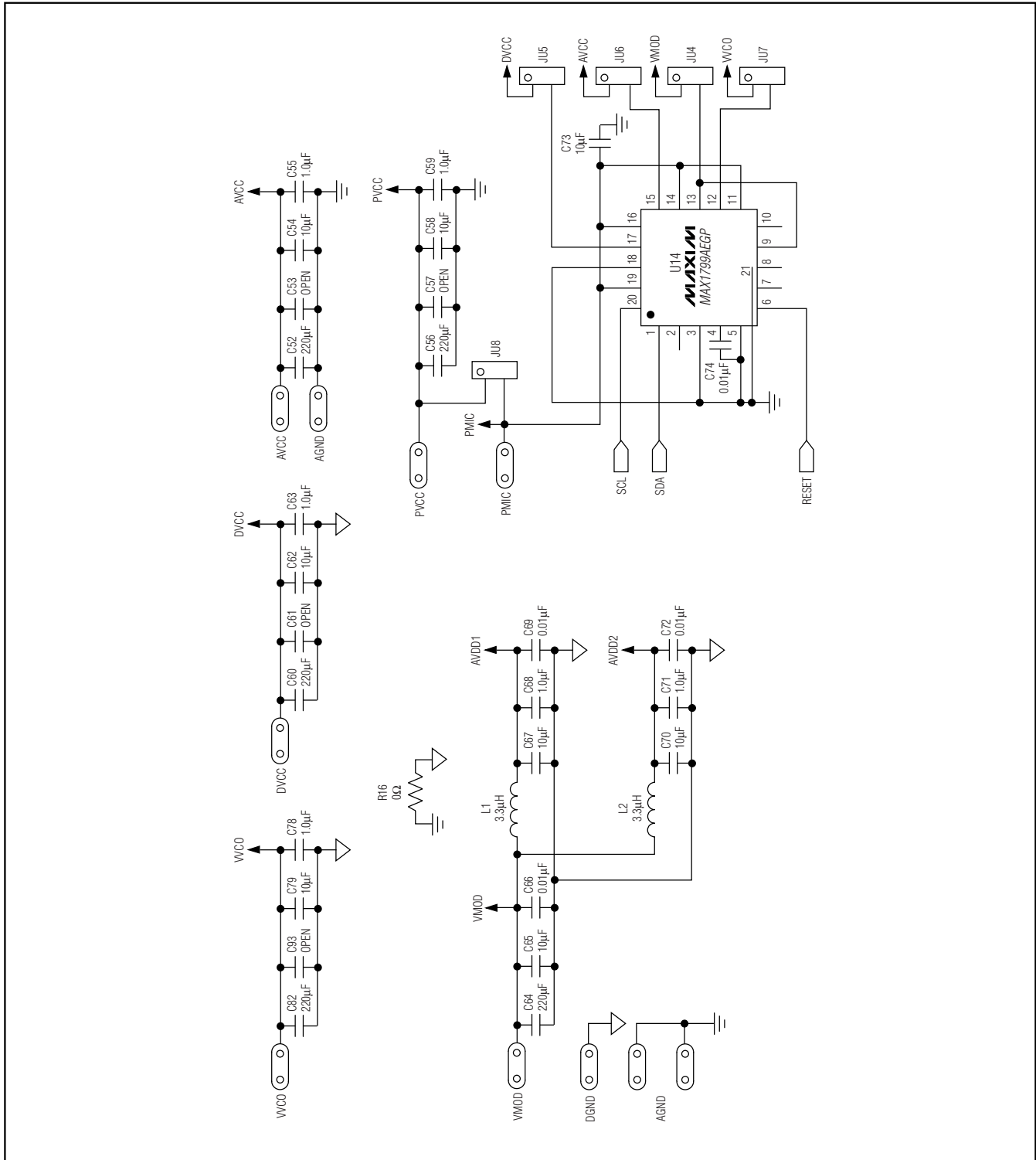

Figure 22. MAX9851 EV Kit Schematic (Sheet 3 of 3)

# MAX9851 Evaluation Kit/Evaluation System

Evaluate: MAX9851

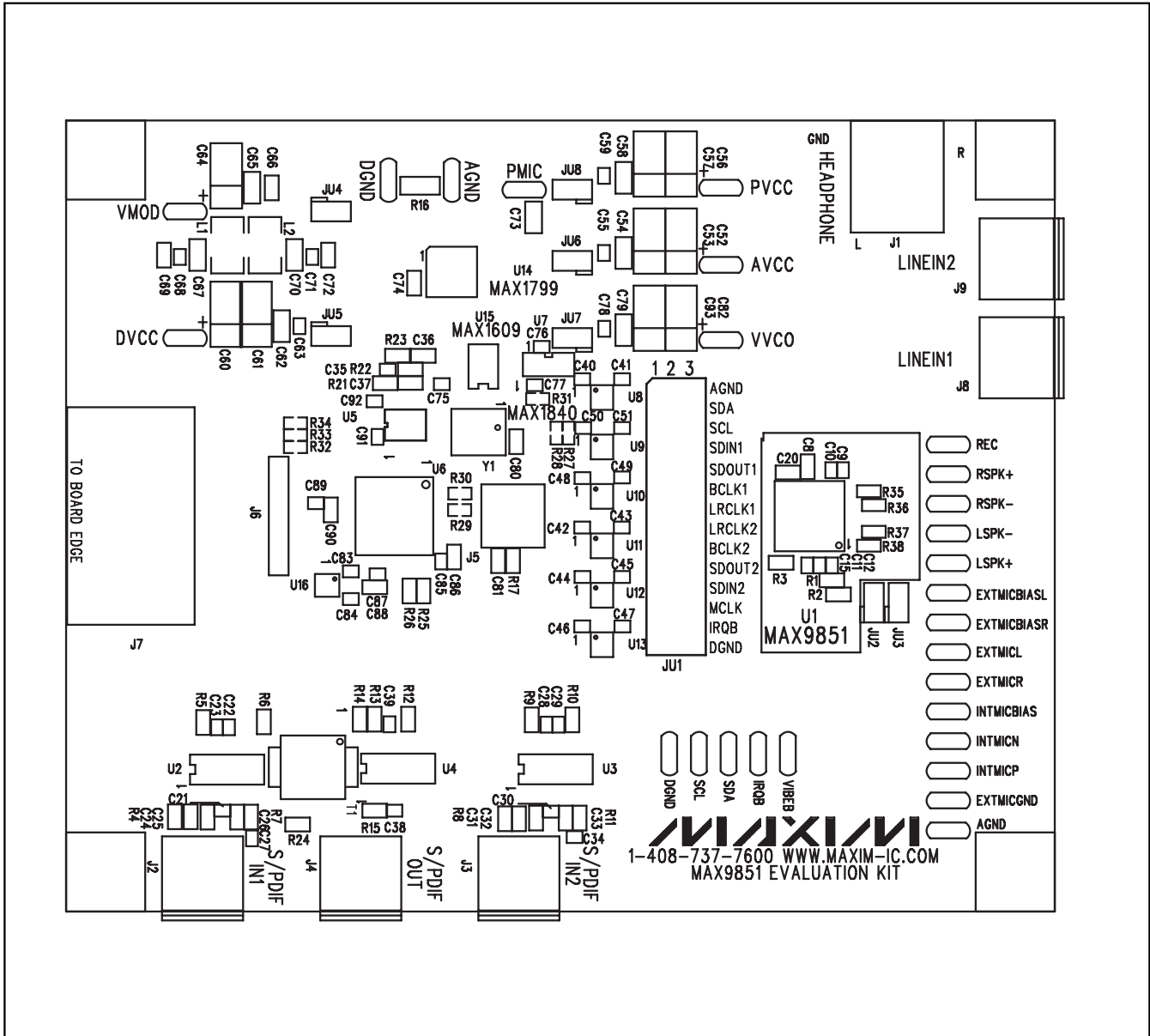

Figure 23. MAX9851 EV Kit Component Placement Guide—Component Side

# MAX9851 Evaluation Kit/Evaluation System

Evaluate: MAX9851

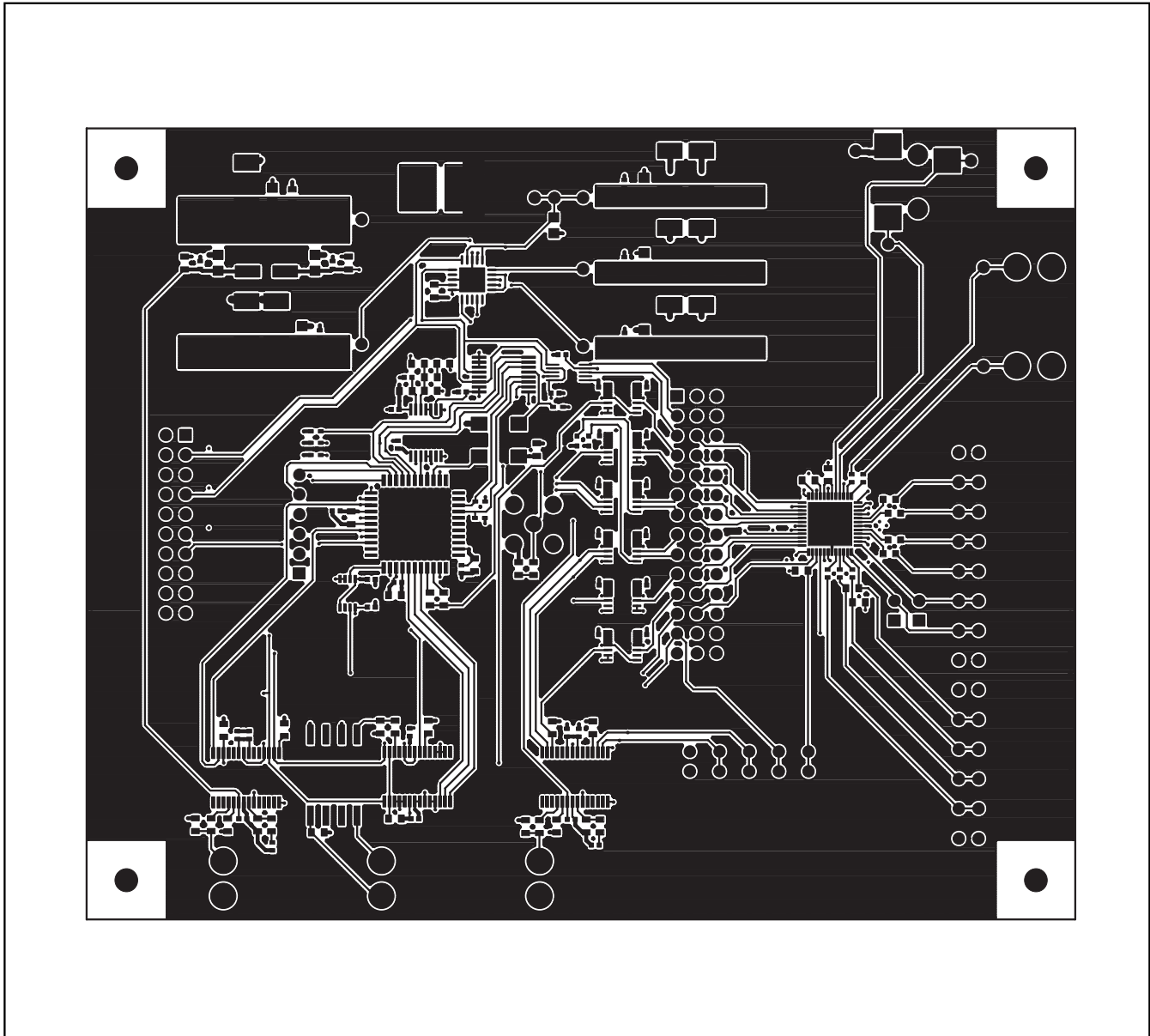

Figure 24. MAX9851 EV Kit PCB Layout—Component Side

# MAX9851 Evaluation Kit/Evaluation System

Evaluate: MAX9851

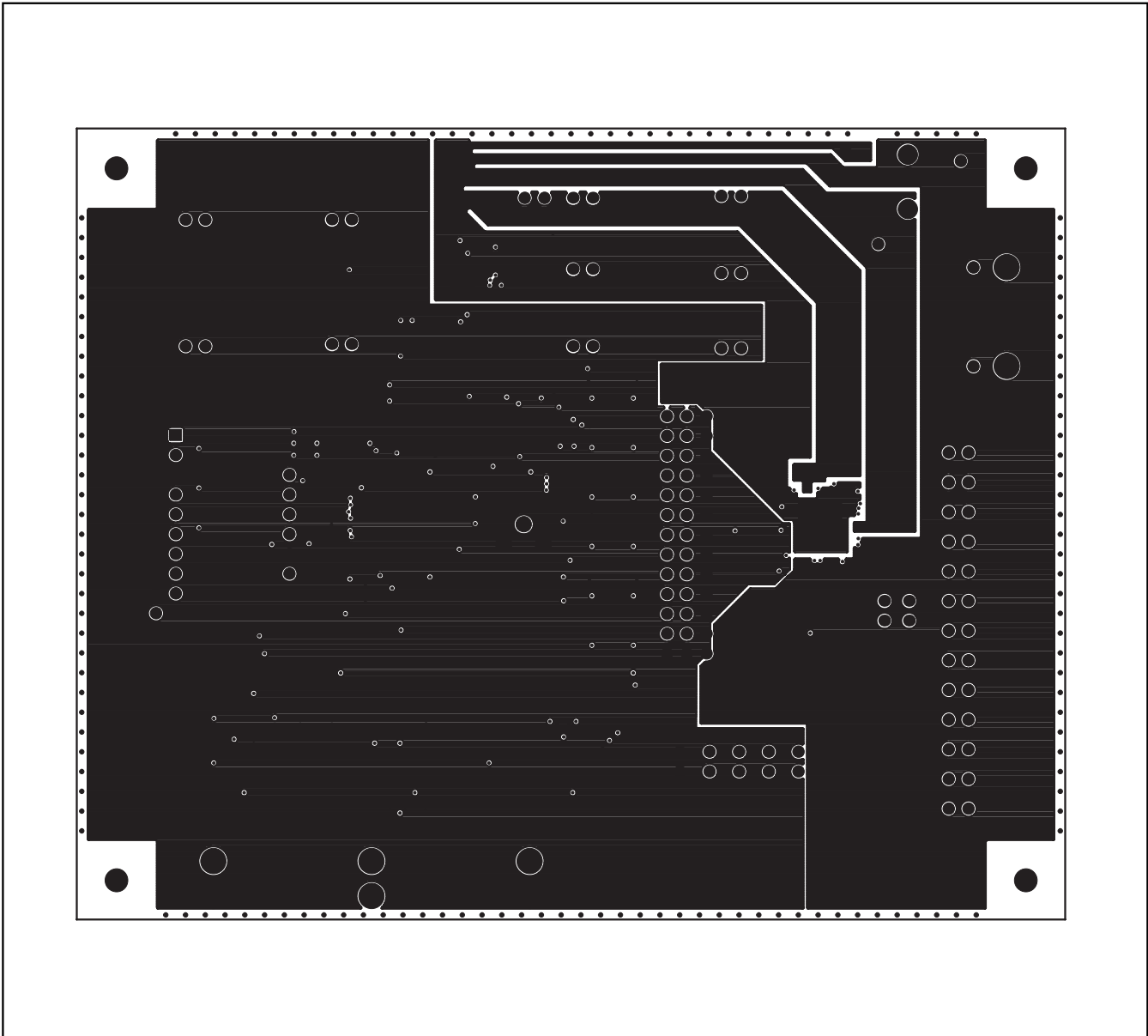

Figure 25. MAX9851 EV Kit PCB Layout—Inner Layer 2

# MAX9851 Evaluation Kit/Evaluation System

**Evaluate: MAX9851**

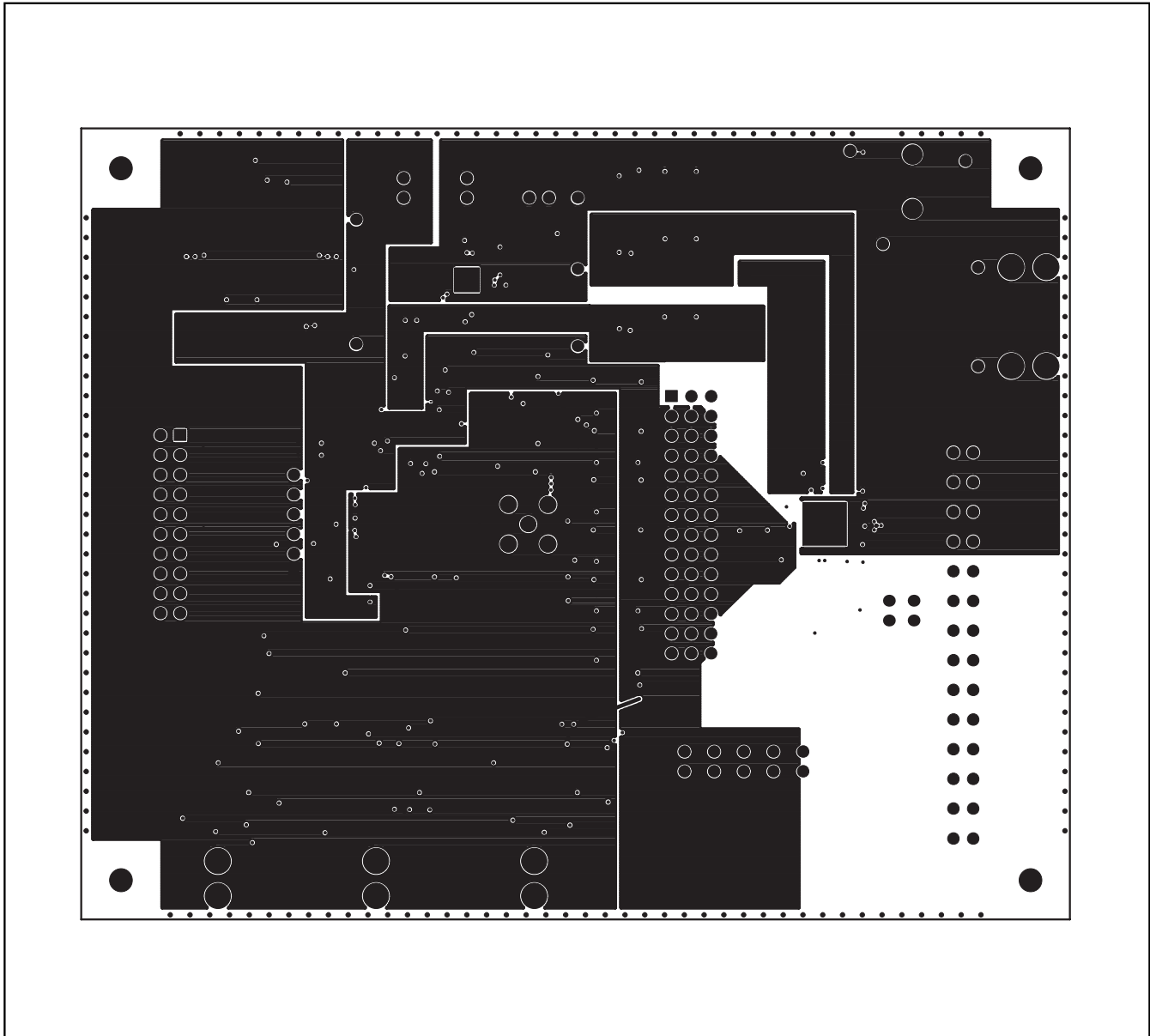

Figure 26. MAX9851 EV Kit PCB Layout—Inner Layer 3

# MAX9851 Evaluation Kit/Evaluation System

Evaluate: MAX9851

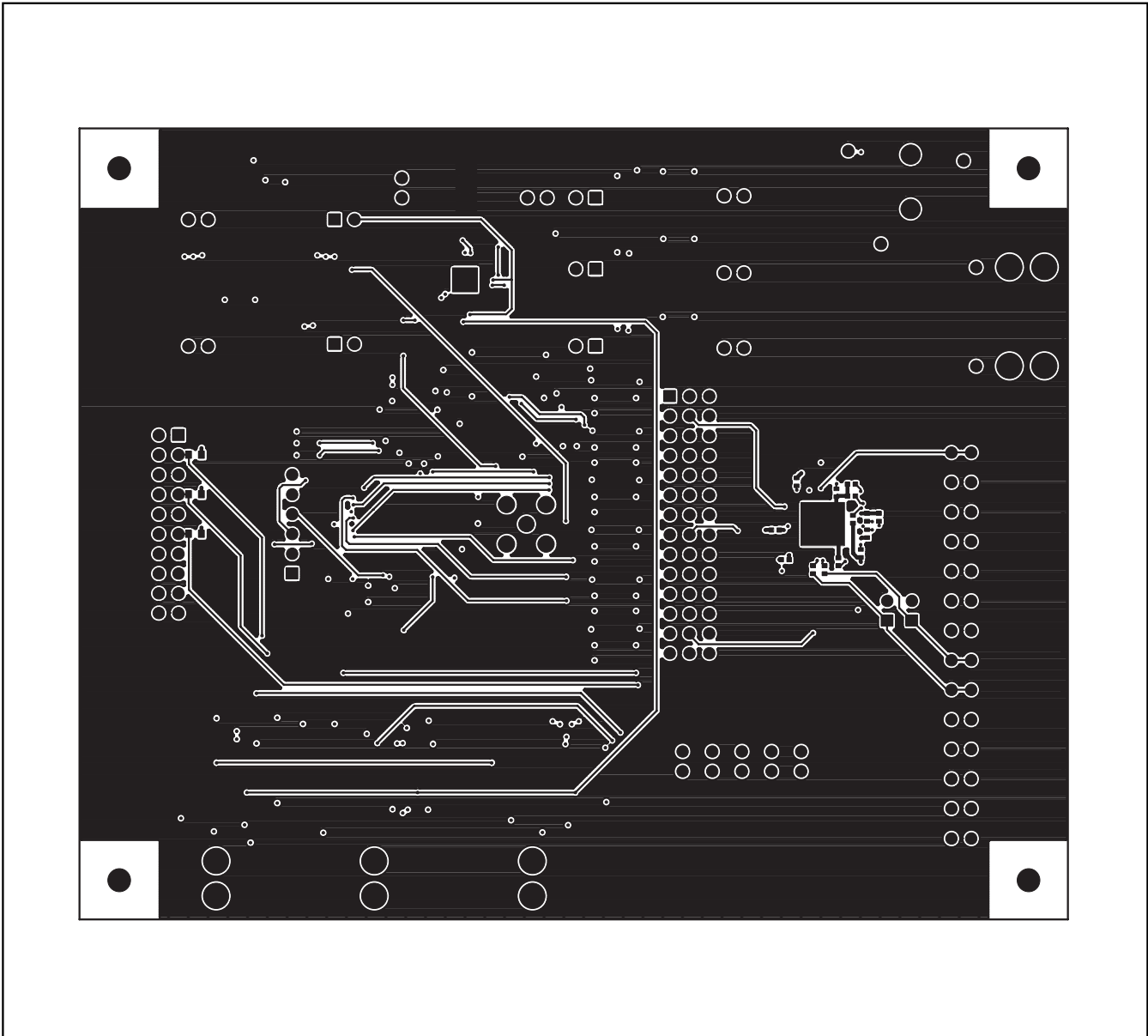

Figure 27. MAX9851 EV Kit PCB Layout—Solder Side

# MAX9851 Evaluation Kit/Evaluation System

Evaluate: MAX9851

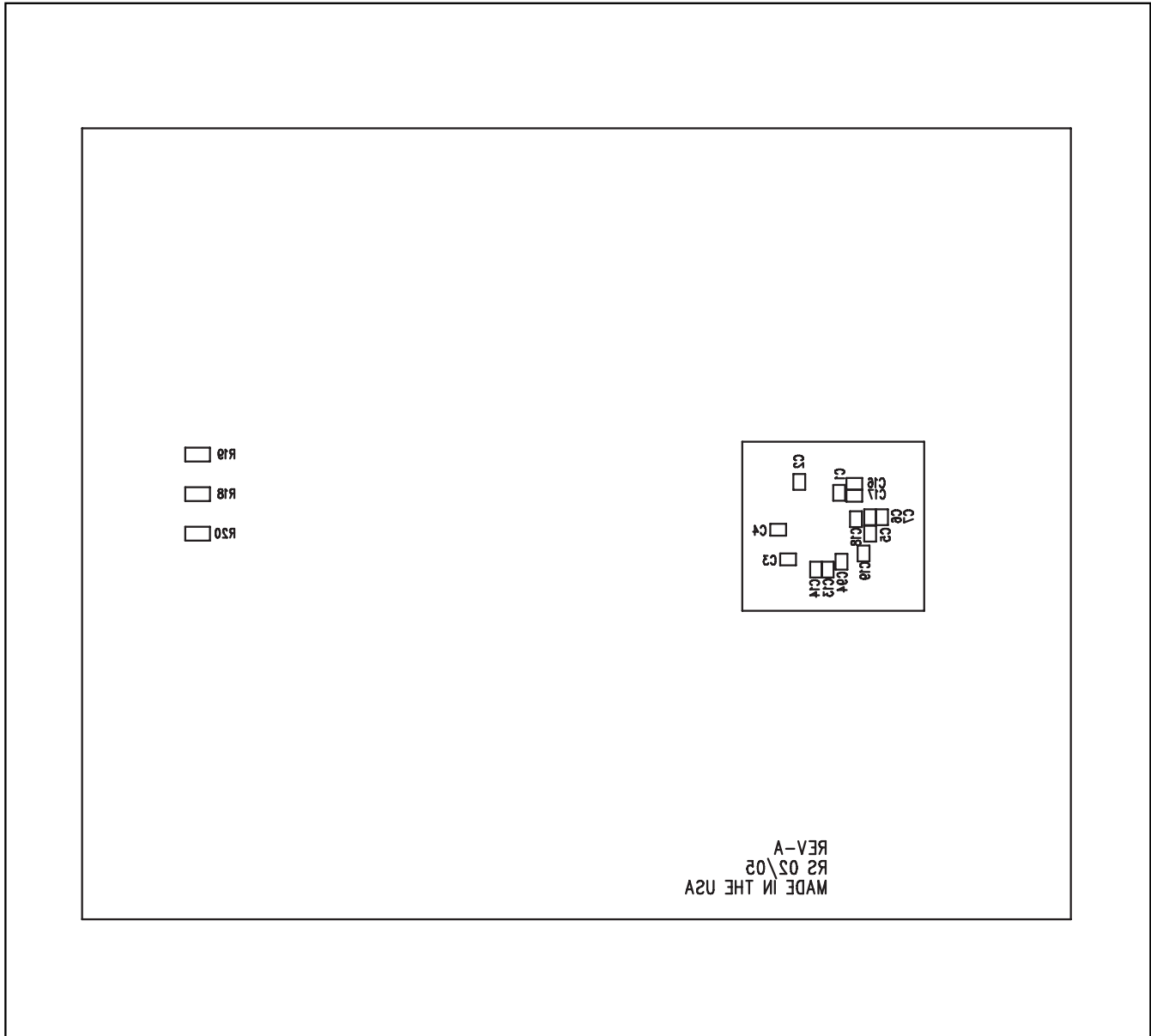

Figure 28. MAX9851 EV Kit Component Placement Guide—Solder Side

## Revision History

Pages changed at Rev 1: 1–4, 16, 28–32

Maxim cannot assume responsibility for use of any circuitry other than circuitry entirely embodied in a Maxim product. No circuit patent licenses are implied. Maxim reserves the right to change the circuitry and specifications without notice at any time.

32 Maxim Integrated Products, 120 San Gabriel Drive, Sunnyvale, CA 94086 408-737-7600